

## Dynamics of leg muscle function in tammar wallabies (*M. eugenii*) during level versus incline hopping

A. A. Biewener<sup>1,\*</sup>, C. McGowan<sup>1</sup>, G. M. Card<sup>1,†</sup> and R. V. Baudinette<sup>2</sup>

<sup>1</sup>Concord Field Station, Department of Organismic and Evolutionary Biology, Harvard University, Cambridge, MA 02138, USA and <sup>2</sup>Department of Environmental Biology, University of Adelaide, Adelaide, SA 5003, Australia

\*Author for correspondence (e-mail: abiewener@oeb.harvard.edu)

†Present address: Department of Bioengineering, California Institute of Technology, Pasadena, CA 92115, USA

Accepted 24 October 2003

### Summary

The goal of our study was to examine whether the *in vivo* force–length behavior, work and elastic energy savings of distal muscle–tendon units in the legs of tammar wallabies (*Macropus eugenii*) change during level versus incline hopping. To address this question, we obtained measurements of muscle activation (*via* electromyography), fascicle strain (*via* sonomicrometry) and muscle–tendon force (*via* tendon buckles) from the lateral gastrocnemius (LG) and plantaris (PL) muscles of tammar wallabies trained to hop on a level and an inclined (10°, 17.4% grade) treadmill at two speeds (3.3 m s<sup>-1</sup> and 4.2 m s<sup>-1</sup>). Similar patterns of muscle activation, force and fascicle strain were observed under both level and incline conditions. This also corresponded to similar patterns of limb timing and movement (duty factor, limb contact time and hopping frequency). During both level and incline hopping, the LG and PL exhibited patterns of fascicle stretch and shortening that yielded low levels of net fascicle strain [LG: level, -1.0±4.6% (mean ± S.E.M.) vs incline, 0.6±4.5%; PL: level, 0.1±1.0% vs incline,

0.4±1.6%] and muscle work (LG: level, -8.4±8.4 J kg<sup>-1</sup> muscle vs incline, -6.8±7.5 J kg<sup>-1</sup> muscle; PL: level, -2.0±0.6 J kg<sup>-1</sup> muscle vs incline, -1.4±0.7 J kg<sup>-1</sup> muscle). Consequently, neither muscle significantly altered its contractile dynamics to do more work during incline hopping. Whereas electromyographic (EMG) phase, duration and intensity did not differ for the LG, the PL exhibited shorter but more intense periods of activation, together with reduced EMG phase ( $P<0.01$ ), during incline versus level hopping. Our results indicate that design for spring-like tendon energy savings and economical muscle force generation is key for these two distal muscle–tendon units of the tammar wallaby, and the need to accommodate changes in work associated with level versus incline locomotion is achieved by more proximal muscles of the limb.

Key words: muscle–tendon unit, work, elastic energy, force–length, lateral gastrocnemius, plantaris, muscle, hopping, locomotion, tammar wallaby, *Macropus eugenii*.

### Introduction

The limb muscles of terrestrial animals must perform a range of functions to accommodate the changing mechanical demands associated with movement in their natural environment. Even during steady-speed locomotion, certain muscles or muscle–tendon groups may be expected to function differently from others. In part, this is likely to be related to differences in their muscle–tendon architecture. For example, the short-fibered pinnate leg muscles of various animals with long tendons have been observed to contract with little length change (Biewener, 1998b; Roberts et al., 1997). Their role has been interpreted as favoring economical force development and facilitation of elastic energy recovery from their aponeurosis and tendon, as opposed to performing mechanical work (Biewener, 1998a; Biewener and Roberts, 2000; Roberts et al., 1997). Indeed, the more extremely specialized muscle–tendon units of large ungulates, such as the digital

flexors of horses, cannot function to modulate mechanical work because the muscles' fibers are so short relative to their tendons' lengths (Ker et al., 1988; Biewener, 1997). Recent experimental evidence indicates that these muscles may instead provide a means of damping out unwanted vibrations within the limb (Wilson et al., 2001). By contrast, longer parallel-fibered muscles that tend to be more proximally located within the limb may undergo larger length changes associated with a greater role in providing net energy production (positive work) or absorption (negative work), even when an animal travels at steady speed over level ground.

When an animal changes speed, or moves uphill or downhill, shifts in muscle shortening or lengthening are clearly required to modulate work output within the limb as a whole. This raises the question of whether all muscles contribute similarly to the shift in net work or whether certain muscle groups are recruited

Table 1. *Muscle–tendon anatomy*

|   | Lateral gastrocnemius |                   |                   |                        |                    |                                | Plantaris         |                   |                        |                    |                                |
|---|-----------------------|-------------------|-------------------|------------------------|--------------------|--------------------------------|-------------------|-------------------|------------------------|--------------------|--------------------------------|
|   | Body mass (kg)        | Muscle mass (g)   | Fiber length (mm) | Pinnation angle (deg.) | Tendon length (mm) | Tendon area (mm <sup>2</sup> ) | Muscle mass (g)   | Fiber length (mm) | Pinnation angle (deg.) | Tendon length (mm) | Tendon area (mm <sup>2</sup> ) |
| 1 | 6.74                  | 16.65             | 21.5              | 26                     | 170                | 7.02                           | 30.80             | 15.5              | 31                     | 242                | 7.78                           |
| 2 | 5.77                  | 11.86             | 18.8              | 27                     | 166                | 7.25                           | 25.82             | 16.5              | 30                     | 241                | 9.26                           |
| 3 | 6.76                  | 11.59             | 22.3              | 26                     | 179                | 7.69                           | 28.81             | 16.5              | 33                     | 247                | 7.90                           |
| 4 | 7.15                  | 15.19             | 22.5              | 23                     | 175                | 7.96                           | 30.10             | 17.4              | 23                     | 249                | 8.79                           |
|   | <b>6.61±0.59</b>      | <b>13.82±2.50</b> | <b>21.3±1.7</b>   | <b>26±2</b>            | <b>173±3</b>       | <b>7.48±0.21</b>               | <b>28.88±2.21</b> | <b>16.5±0.8</b>   | <b>29±4</b>            | <b>245±2</b>       | <b>8.43±0.37</b>               |

Values in bold represent means  $\pm$  S.E.M. of all four animals.

specifically for such tasks and are better suited for modulating work performance. In this paper, we specifically examine the question of whether the highly specialized distal leg muscle–tendon units of tammar wallabies (*Macropus eugenii*) are capable of shifting their contractile performance to contribute increased work when wallabies hop up an incline. In their study of wild turkeys (*Meleagris gallopavo*), Roberts et al. (1997) found that the lateral gastrocnemius (LG) was able to shift from economical, near isometric, behavior during level running to increased shortening and work production during uphill running. Thus, despite having an architecture that favors force economy and tendon elastic savings, the turkey LG's contractile performance was capable of contributing to the additional potential energy work associated with lifting the animal's center of mass as it moved uphill. In the present study, we examine the same question by comparing the contractile performance of the plantaris (PL) and LG muscle–tendon units of tammar wallabies (*Macropus eugenii*) during level *versus* incline (10°) hopping on a treadmill. Our previous study of these two muscles during steady level hopping over a broad range of speeds showed that both muscles contracted with limited length change (PL: <2%; LG: <5%), similar to the length change observed for the turkey LG (<6%; Roberts et al., 1997). As a result, net muscle work was negligible compared with the amount of elastic energy stored and recovered in the muscles' tendons. In the present study, we test the hypothesis that, unlike the turkey LG, the specialized design of the leg muscles and tendons of tammar wallabies, associated with their ability to recover substantial elastic energy during hopping, dramatically reduce metabolic energy rates (Baudinette et al., 1992), results in no change in their contractile role during level *versus* incline hopping. In a related study (Daley and Biewener, 2003), we examine the same question for two agonist distal leg muscles of the guinea fowl (*Numida meleagris*). Although muscles of similar mass but differing fiber length should have similar capacity for performing work, our hypothesis is that distal leg muscles with short fibers and long tendons will generally be more constrained than longer-fibered proximal muscles in shifting their contractile performance to adjust their work output associated with acceleration and deceleration, or changes in grade.

### Materials and methods

Four healthy adult tammar wallabies (*Macropus eugenii*; body mass, 6.61±0.59 kg; two females, two males) obtained from a captive breeding colony maintained in large outdoor paddocks (30 m×40 m) at the Waite Campus of the University of Adelaide were trained to hop on a motorized treadmill (belt dimensions, 2.0 m long × 0.6 m wide) at 3.3 m s<sup>-1</sup> and 4.2 m s<sup>-1</sup> on the level and on a 10° incline (17.4% grade). After 2–3 weeks of training (involving 30 min bouts of exercise under both level and incline conditions), each animal was instrumented with tendon force buckles, sonomicrometry (SONO) crystals and electromyographic (EMG) electrodes.

#### *Surgical approach and transducer design/implantation*

The general surgical approach, implantation sites and design of the transducers were similar to our earlier study of level locomotion (Biewener et al., 1998) but are briefly described here. Animals were anesthetized using isoflourane gas administered by a mask. Animals were induced at 3–4% and maintained at 1.5–2% during the surgical procedure. All electrodes were soaked in a bacterial disinfecting solution (Cetylcide™ disinfectant) and placed in a UV-sterilizing surgical instrument container overnight prior to surgery. The bellies of the lateral gastrocnemius (LG) and plantaris (PL) were exposed by a postero-lateral skin incision. All electrodes and transducers were then passed subcutaneously from a small incision made above the hip over the pelvis to the opening in the leg over the muscles. Piezoelectric SONO crystals (2.0 mm; Sonometrics™) were inserted parallel to the fascicles in the mid-region of the LG by piercing the fascial epimysium of the muscle and creating a small pocket, with sharp-pointed scissors, into which the crystal was inserted. Because the LG is unipennate, crystals were inserted to varying depth to match the pinnation angle of the fascicles (26°; Table 1). Pairs of crystals, located 10–14 mm apart, were then aligned to maximize their signal-to-noise ratio. This was done by monitoring the transducers' output *via* the recording cable connected to a sonomicrometer amplifier (Triton 120.1), with the signals displayed on a Tektronix 2205 oscilloscope during the surgical procedure. After optimal alignment was established, the crystals were anchored into position by

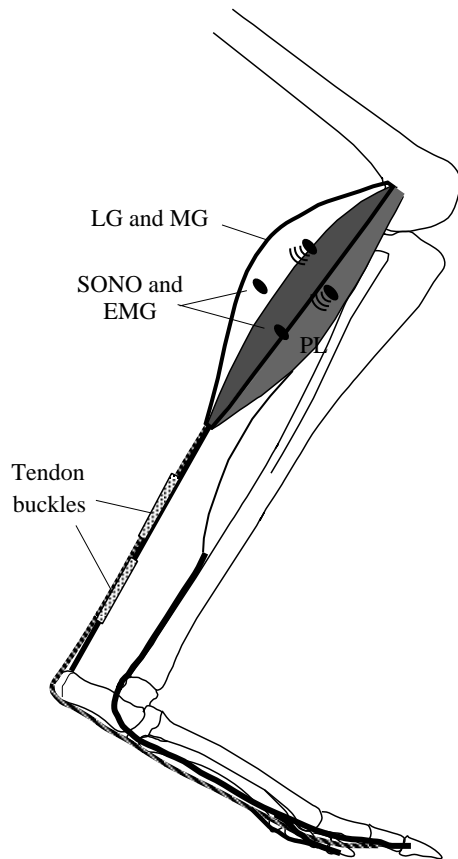

Fig. 1. Diagram showing the muscle-tendon anatomy of the tamar wallaby hindlimb and the positions of attachment of the tendon force buckles and implantation of the sonomicrometry (SONO) and electromyographic (EMG) electrodes in the lateral gastrocnemius (LG) and plantaris (PL) muscle bellies.

suturing the openings and anchoring the lead wires to the muscle's surface with 4-0 silk. Bipolar off-set twist hook EMG electrodes (0.1 mm silver enamel insulated; California Fine Wire) were then implanted immediately adjacent to each crystal pair. Access to the PL required making an incision through the aponeurosis connecting the lateral and medial (MG) heads of the gastrocnemius to expose the PL, which lies deep to the MG and LG. The PL is a multipennate muscle. SONO crystals and EMG electrodes were implanted in a medial compartment of the PL, which was selected as a site for obtaining fascicle length recordings in order to minimize disruption to the overlying MG and LG (Fig. 1). Interpretations of muscle length change for the LG (and MG) and PL are therefore based on these localized recordings of fascicle length change, which are assumed to be representative of the muscle as a whole (see below).

After implanting the muscle transducers, stainless-steel E-shaped tendon buckle force transducers (Biewener et al., 1998) were implanted on the PL and common Achilles tendons (Fig. 1). Exposure of the tendons was achieved by extending the incision from the muscle bellies parallel to the tendons. The tendon buckles were implanted so that they did

not interfere with each other when the ankle was passively flexed and extended. Their position was secured with 3-0 suture sewn through an edge of the tendon and anchored to the buckle via a figure-of-eight loop passed through the fastening holes in the buckle arms. Because the soleus muscle in tamar wallabies is extremely small and merges with the LG muscle and aponeurosis (Biewener et al., 1998), the Achilles tendon buckle measured the combined force of the MG, LG and soleus.

Animals were allowed to recover from surgery for 24–36 h and then hopped at the two speeds and two inclines for several repeated trials, sufficient to yield 10–15 steady hops for any trial and condition. High-speed digital video recordings (Redlake, PCI-500 at 125 Hz) were also obtained of the animals in lateral view. The videos were synchronized to the muscle-tendon recordings by means of a post-trigger pulse sampled together with the muscle-tendon signals at 5 kHz by means of a BioWare™ type 2812A1-3 A/D system (DAS1602/16 A/D board; Kistler Instruments Corp., Amherst, NY, USA) operated using BioWare™ v.3.0 software. Experimental data stored on disk were subsequently analyzed using IGOR Pro and customized Matlab (v.5.3; The MathWorks, Natick, MA, USA) routines.

#### *Muscle fascicle length change and force*

Measurements of the fractional length change of muscle fascicles were based on the change in length between crystal pairs relative to their resting length ( $L_{\text{frac}} = \Delta L / L_{\text{rest}}$ ). Resting length was determined both when the animal was lying at rest in a burlap bag in between treadmill trials and again post-mortem. Values of  $L_{\text{rest}}$  measured for both conditions were the same. Before analysis, fractional length recordings were corrected for the offset error introduced by the faster speed of sound propagation through the epoxy lens of the crystals relative to the muscle (determined to be 0.82 mm for the Sonometrics™ 2.0 mm crystals) and for the 5 ms delay introduced by the Triton 120.1 amplifier's filter. Mean fascicle length changes for the muscle as a whole were calculated as  $\Delta L_{\text{tot}} = L_{\text{frac}} \times L_f$ , where  $L_f$  is the mean fascicle length of the muscle. This assumes that all fascicles within the muscle undergo uniform length changes. While this may not be the case, and requires verification by future studies, our measurements do not allow us to test this assumption.

After completing the experimental recordings, the animals were euthanized (gas anesthesia followed by 100 mg kg<sup>-1</sup> sodium pentobarbital injected by cardiac puncture) and the locations and alignment of the SONO crystals and EMG electrodes verified by dissection of the muscles *in situ*. In all cases, crystal alignment was found to be within 0–7° of the fascicle axis (so that errors due to crystal alignment were less than 1%). Exposure and inspection of the tendons showed no significant signs of inflammation or damage by the buckle transducers. The distal-most portion of the muscle and its aponeurosis were then cut and isolated with the tendons, which were left with their distal ankle and foot skeletal attachments left intact. The proximal end of the muscle and aponeurosis

were then tied repeatedly and secured to a uniaxial tension transducer with heavy nylon cord (250 N capacity). The tied proximal end was then immersed in liquid nitrogen and frozen. Before conducting tensile force calibrations, the buckle transducer and adjacent region of the tendon were warmed to room temperature (25°C). The difference in test (room) temperature *versus in vivo* temperature was considered to have a negligible effect on the buckle calibrations. Repeated *in situ* pull calibrations of the isolated tendons yielded simultaneous recordings of force and buckle voltage output that were calibrated by means of least-squares regression during both the rise and fall in force. This provided a dynamic calibration of *in vivo* muscle–tendon force measured by the tendon buckle. This was repeated for the second isolated tendon. As in our previous experiments (Biewener et al., 1998), we observed only a slight hysteresis in slope (difference in the force rise slope being less than 2% of the slope of force decline), with  $r^2$  values exceeding 0.985.

#### EMG signal intensity

EMG intensity for single bursts of muscle activation was determined by averaging the spike amplitude of the rectified EMG signal. EMG intensities were then converted to a relative scale for each muscle by dividing this value by the largest value recorded in that muscle for that animal. Thus, for a given animal, the largest burst intensity recorded in a given muscle was assigned the value of 1, and all other bursts from that muscle ranged between 0 and 1.

#### Muscle and tendon stress and tendon elastic strain energy

To obtain measurements of tendon and muscle cross-sectional area for computing muscle and tendon stress and tendon elastic energy savings, the tendons of the contralateral PL and LG + MG were dissected free, their lengths measured, and weighed to the nearest 0.1 mg using an electronic balance. The short portion of the plantaris tendon that passes over the calcaneus was excised before weighing. Previous work (Ker et al., 1986) has shown that this portion has a lower elastic modulus than the intervening lengths of the tendons. Measurement of tendon area was made assuming a density of 1120 kg m<sup>-3</sup> for tendon (Ker, 1981). Tendon volume was then calculated assuming a uniform tendon area from muscle origin to tendon insertion and by subtracting the muscle's fiber length from overall muscle–tendon length to obtain the tendon's 'net length'. Tendon elastic energy recovery was calculated using a modulus of 1.0 GPa to account for the lower modulus of tendon at low (<3%) strains and a resilience of 93% (Ker, 1981; Bennett et al., 1986; Shadwick, 1990).

Before making measurements from the muscles, EMG electrode implantation sites were verified for proper location in the muscle's belly. The freshly isolated muscles were then weighed (to the nearest 0.01 g of their mass,  $M$ ) and, using a no. 10 scalpel, sectioned in a plane parallel to the muscle fibers. Measurements of fiber length ( $l$ ) and pennation angle ( $\alpha$ ) were then made at regular intervals (six per muscle) along the muscle's length using digital calipers and a protractor to calculate the muscle's fiber cross-sectional area. Effective fiber

Table 2. Muscle, tendon and stride parameters during level versus incline hopping (data averaged for 3.3 m s<sup>-1</sup> and 4.2 m s<sup>-1</sup>)

|                                   | Level        | Incline      | $F_{(1,3)}$ | $P$   |
|-----------------------------------|--------------|--------------|-------------|-------|
| Gastrocnemius                     |              |              |             |       |
| LG EMG phase (ms)                 | -48±11       | -50±16       | 0.003       | 0.956 |
| LG EMG duration (ms)              | 106±7        | 106±14       | 0.016       | 0.900 |
| LG EMG relative intensity         | 0.653±0.026  | 0.685±0.021  | 1.207       | 0.274 |
| Gastrocnemius force (N)           | 202±18       | 185±13       | 9.480       | 0.003 |
| Gastrocnemius stress (kPa)        | 133.9±12.5   | 123.4±10.2   |             |       |
| LG strain (net, stance)           | -0.010±0.046 | 0.006±0.045  | 0.061       | 0.805 |
| Gastrocnemius work (J)            | -0.134±0.125 | -0.111±0.111 | 0.439       | 0.509 |
| Gastrocnemius tendon stress (MPa) | 26.3±2.7     | 24.2±2.1     |             |       |
| Gastrocnemius tendon energy (J)   | 0.43±0.07    | 0.36±0.05    |             |       |
| Plantaris                         |              |              |             |       |
| PL EMG phase (ms)                 | -19±6        | -12±10       | 6.268       | 0.013 |
| PL EMG duration (ms)              | 100±9        | 87±11        | 32.554      | 0.001 |
| PL EMG relative intensity         | 0.484±0.015  | 0.706±0.020  | 87.247      | 0.001 |
| PL force (N)                      | 199±18       | 216±25       | 4.298       | 0.040 |
| PL stress (kPa)                   | 138.6±13.8   | 151.1±17.0   |             |       |
| PL strain (net, stance)           | 0.001±0.010  | 0.004±0.016  | 0.261       | 0.610 |
| PL work (J)                       | -0.060±0.019 | -0.042±0.019 | 2.175       | 0.143 |
| PL tendon stress (MPa)            | 23.9±3.0     | 26.0±3.4     |             |       |
| PL tendon energy (J)              | 0.46±0.10    | 0.55±0.13    |             |       |
| Stride frequency (Hz)             | 3.46±0.60    | 3.49±0.11    | 0.631       | 0.429 |
| Ground contact time (s)           | 0.112±0.003  | 0.119±0.004  | 0.058       | 0.810 |
| Duty factor                       | 0.388±0.008  | 0.388±0.023  | 0.353       | 0.553 |

Values are means ± S.E.M. ( $N=4$ ). EMG phase is relative to foot down. EMG relative intensity represents normalized mean spike amplitude.



cross-sectional area ( $=M\cos(\alpha)/\rho l$ ) was calculated using the mean values obtained for these measurements (Table 1), using a density ( $\rho$ ) of  $1060 \text{ kg m}^{-3}$  for the muscle. Slight errors in the plane of section and possible distortion in the resting length of the fresh muscle during the sectioning and measurement procedures introduce some uncertainty for the values of resting fiber length and cross-sectional area obtained using this approach. Measurements of muscle work for the gastrocnemius muscle as a whole were based on the length changes recorded in the LG fascicles because the force measurements are for both LG and MG heads. We chose this approach because of the uncertainty of partitioning the amount of force that each head contributed separately to our combined tendon force buckle recordings.

## Results

### *In vivo force-length behavior*

In all four animals (Table 2; Fig. 2), the LG and PL exhibited uniform contractile behavior when the wallabies hopped on a level compared with when they hopped on a  $10^\circ$  incline. This was the case at both  $3.3 \text{ m s}^{-1}$  and  $4.2 \text{ m s}^{-1}$ . For both level and incline conditions, the LG was initially stretched as it developed force and then remained close to isometric or shortened during the second half of stance. Net fascicle strain in the LG averaged  $-1.0 \pm 4.6\%$  ( $\pm$  S.E.M. throughout) during level hopping and  $0.6 \pm 4.5\%$  during incline hopping at both speeds (Table 2). Under both level and incline conditions, PL fascicles were stretched early in stance, developed maximum force under isometric conditions and then shortened during the latter portion of stance as force declined (Fig. 2). Net fascicle strain in the PL averaged  $0.1 \pm 1.0\%$  during level hopping and  $0.4 \pm 1.6\%$  during incline hopping at both speeds (Table 2). Analysis of variance (ANOVA) showed that these differences were insignificant when compared across level *versus* incline conditions (Table 2), as well as when compared across the two speeds (LG:  $F_{(1,3)}=1.946$ ,

Fig. 2. Representative recordings of muscle-tendon force, fascicle strain and EMG in the plantaris and gastrocnemius muscles of wallaby #2 during (A) level *versus* (B) incline hopping at  $4.2 \text{ m s}^{-1}$ . Whereas gastrocnemius force measured in the Achilles tendon represents the medial gastrocnemius (MG) and lateral gastrocnemius (LG) combined, muscle strain and EMG were recorded from the LG muscle head. Little or no significant differences were observed when animals shifted from level to incline hopping at a given speed. The locomotor cycles showing stance and swing phases are those shown in Fig. 4 to describe the *in vivo* force-length behavior of these muscles.

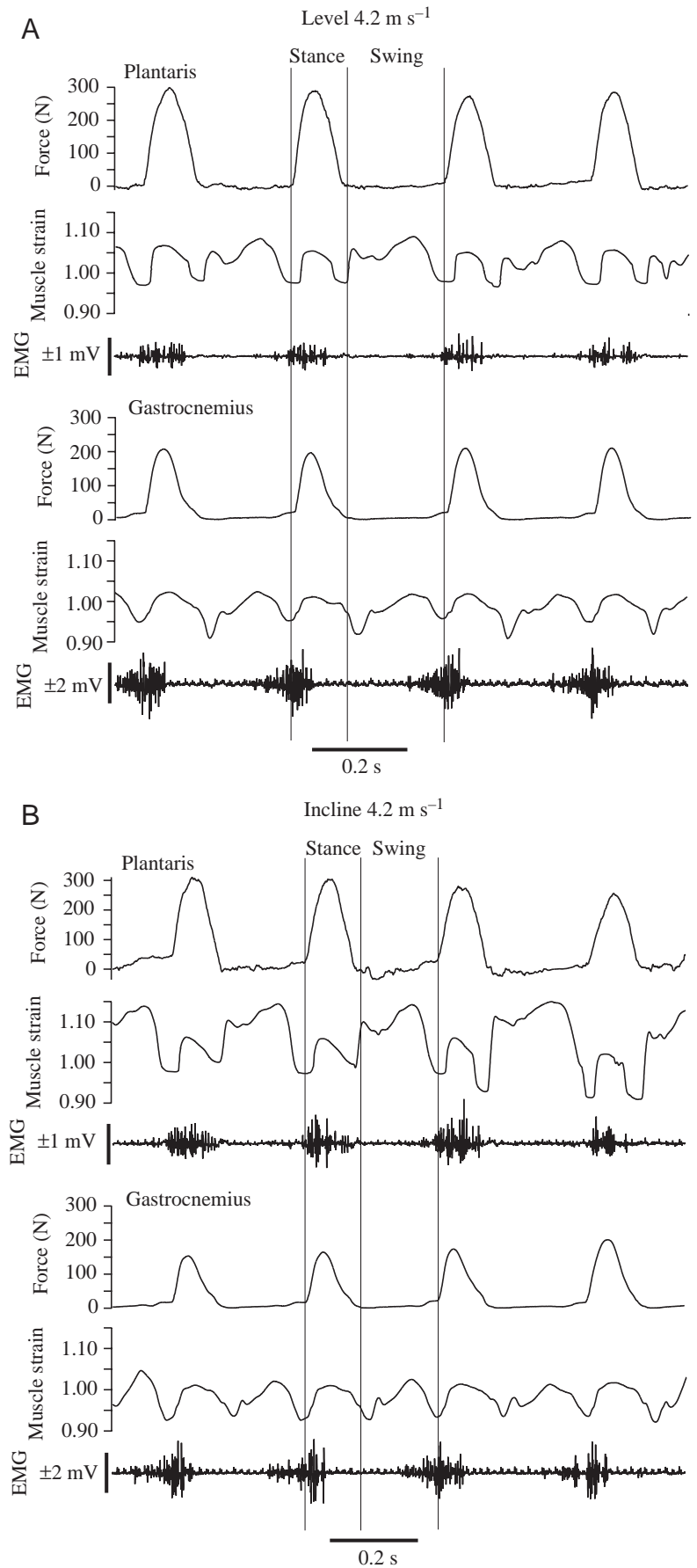

$P=0.165$ ; PL:  $F_{(1,3)}=1.749$ ;  $P=0.188$ ). The patterns of fascicle length change relative to force development observed here matched those we found previously for the same two muscles during level hopping over a broader range of speed ( $2.5\text{--}6.0\text{ m s}^{-1}$ ; Biewener et al., 1998). In addition to the patterns of force generation during the stance phase, we also regularly observed an earlier development of force in the LG muscle–tendon unit that occurred  $36\pm 7\text{ ms}$  (level) and  $35\pm 10\text{ ms}$  (incline) prior to limb contact (Figs 2, 8). This is probably linked to its role in overcoming the foot's inertia associated with the deceleration of the foot during the transition from swing to stance, helping to match foot and ground speeds prior to contact.

#### Joint kinematics

Representative graphs of knee, ankle and metatarsophalangeal (MP) joint angle changes over time for three strides at  $4.2\text{ m s}^{-1}$  by wallaby #1 are shown in Fig. 3. Similar patterns were observed in the other three animals. These data show that the knee and ankle joints flex and extend at the same time during stance, consistent with the small net strains that the biarticular LG and multiarticular PL muscles achieve while producing force (see below). The MP joint shows more variable degrees of initial flexion early in stance, followed by substantial extension during the latter half of limb support. Differences between level *versus* incline hopping are most apparent at the ankle joint, which maintains a more flexed range of excursion during incline hopping. Increased flexion is also most consistently observed at the MP joint during incline hopping late in support, as the animal's limb transitions into its swing phase, but is more variable at the onset of stance. The knee, by contrast, showed little change in flexion during the first half of limb support but extended to a greater degree than the ankle and MP joints late in stance during incline hopping.

#### In vivo 'work loop' patterns

Graphs of muscle–tendon force relative to fascicle length change further demonstrate the similar *in vivo* behavior and work performance of the two hind leg muscles during level and incline hopping (Fig. 4). Although some variation in the patterns of force–length behavior was observed among individual animals, the work loop behavior of the LG and PL was highly consistent within each individual. In general, the LG contracted with varying, but modest, degrees of fascicle shortening and lengthening, yielding in some cases net work output (e.g. wallaby #2) while in others net energy absorption or negative work (e.g. wallaby #3). In all cases, the early rise in LG force ('shoulder' seen in records presented in Fig. 2) was associated with fascicle shortening. As noted above, we interpret this as representing muscle shortening in series with elastic stretch of the muscle's aponeurosis and tendon, when both are most compliant at the onset of force development and the foot is being decelerated prior to ground contact. Force development then rose either in an isometric manner or with moderate stretch of the fascicles (mean LG strain during force rise: level,  $1.27\pm 4.0\%$ ; incline,  $3.14\pm 3.16\%$ ;  $N=4$ ), after the

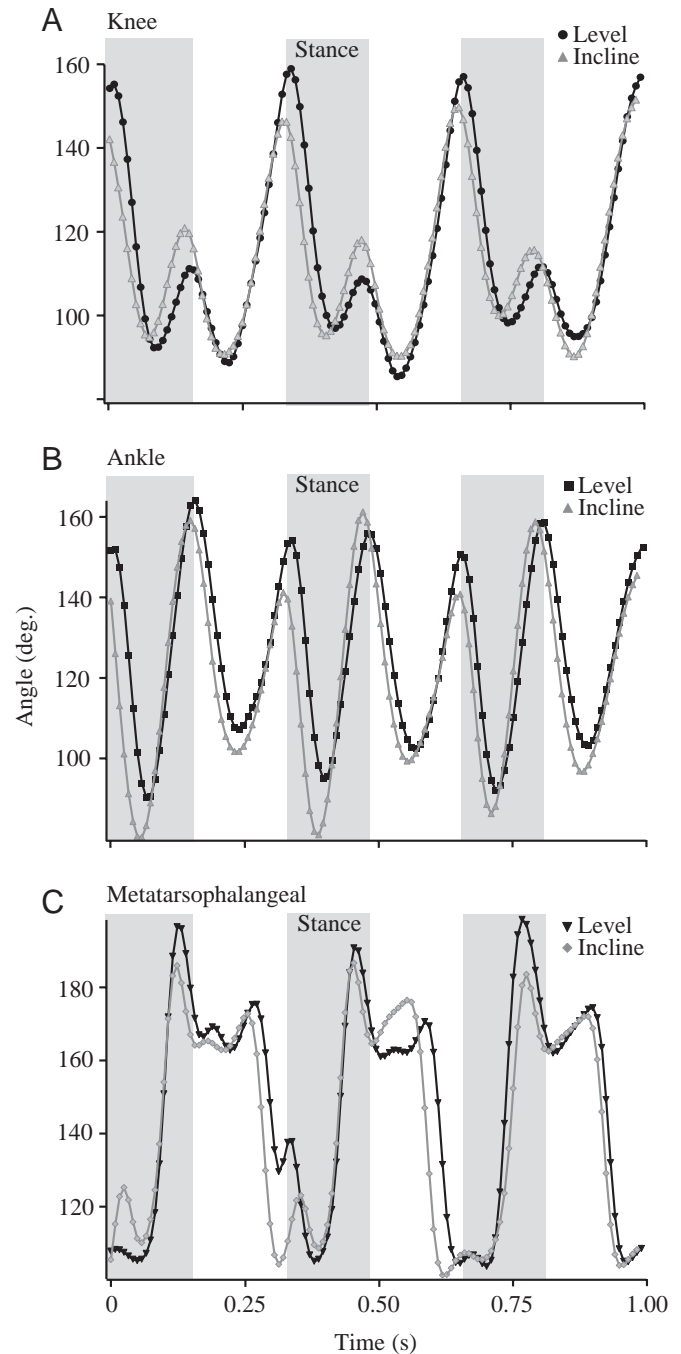

Fig. 3. Representative changes in (A) knee, (B) ankle and (C) metatarsophalangeal (MP) joint angles *versus* time for three strides of wallaby #1 while hopping at  $4.2\text{ m s}^{-1}$  on the level and on an incline. Because of small shifts in relative stance time for level *versus* incline hopping at the same speed, the graphs have been normalized to the same equivalent time period (time base shown is the average for the two conditions).

foot was placed on the ground for weight support. In all cases, the LG fascicles remained nearly isometric or shortened only slightly during the decline in muscle–tendon force later in support (mean LG strain during force decline: level,  $-2.23\pm 1.55\%$ ; incline,  $-2.52\pm 2.21\%$ ;  $N=4$ ).

Fig. 4. Representative *in vivo* work loops (force versus length) performed by (A) the lateral (LG) and medial gastrocnemius (MG) and (B) the plantaris (PL) muscles of wallabies #2 and #3 during level versus incline hopping. The strain and activation patterns for gastrocnemius are based on measurements made of the LG head. The period of muscle EMG is shown in gray. The path of force relative to length change is shown by the arrows. The net work performed (area inside the loop) is also shown for each muscle cycle. Net work is positive when the loop is counterclockwise in nature (e.g. wallaby #2 LG) and negative when the loop moves in a clockwise direction (e.g. wallaby #3 LG). Although different patterns were observed among individual animals, work loop patterns were always consistent across level and incline hopping conditions within an individual animal. The patterns shown here for wallaby #2 versus wallaby #3 differed the most among the four animals. Gastrocnemius work by the two animals not shown was generally more similar to that of wallaby #3. Differences in force-length behavior were generally greater for the gastrocnemius than for the plantaris. In general, the PL did less net work (negative or positive) than the LG.

Although the PL fascicles also showed a brief early phase of shortening at low force levels early in stance (Fig. 4B), this was generally more limited than that observed for the LG fascicles (Fig. 4A). During the rapid rise in force, the fascicles were stretched (mean PL strain: level,  $6.34 \pm 1.25\%$ ; incline,  $7.84 \pm 0.72\%$ ) and then shortened by similar amounts during force decline (mean PL strain: level,  $-6.23 \pm 0.97\%$ ; incline,  $-7.43 \pm 1.21\%$ ;  $N=4$ ).

In general, these patterns of lengthening and shortening fascicle strain during stance were consistent among the four animals studied (Fig. 5). Although the magnitude of lengthening and shortening strain was generally greater in the PL compared with the LG, the net strains of the two muscles over the course of limb support were similar and, as noted above, generally quite small (averaging  $\leq 1\%$ ). As a result, neither muscle shifted its work performance during

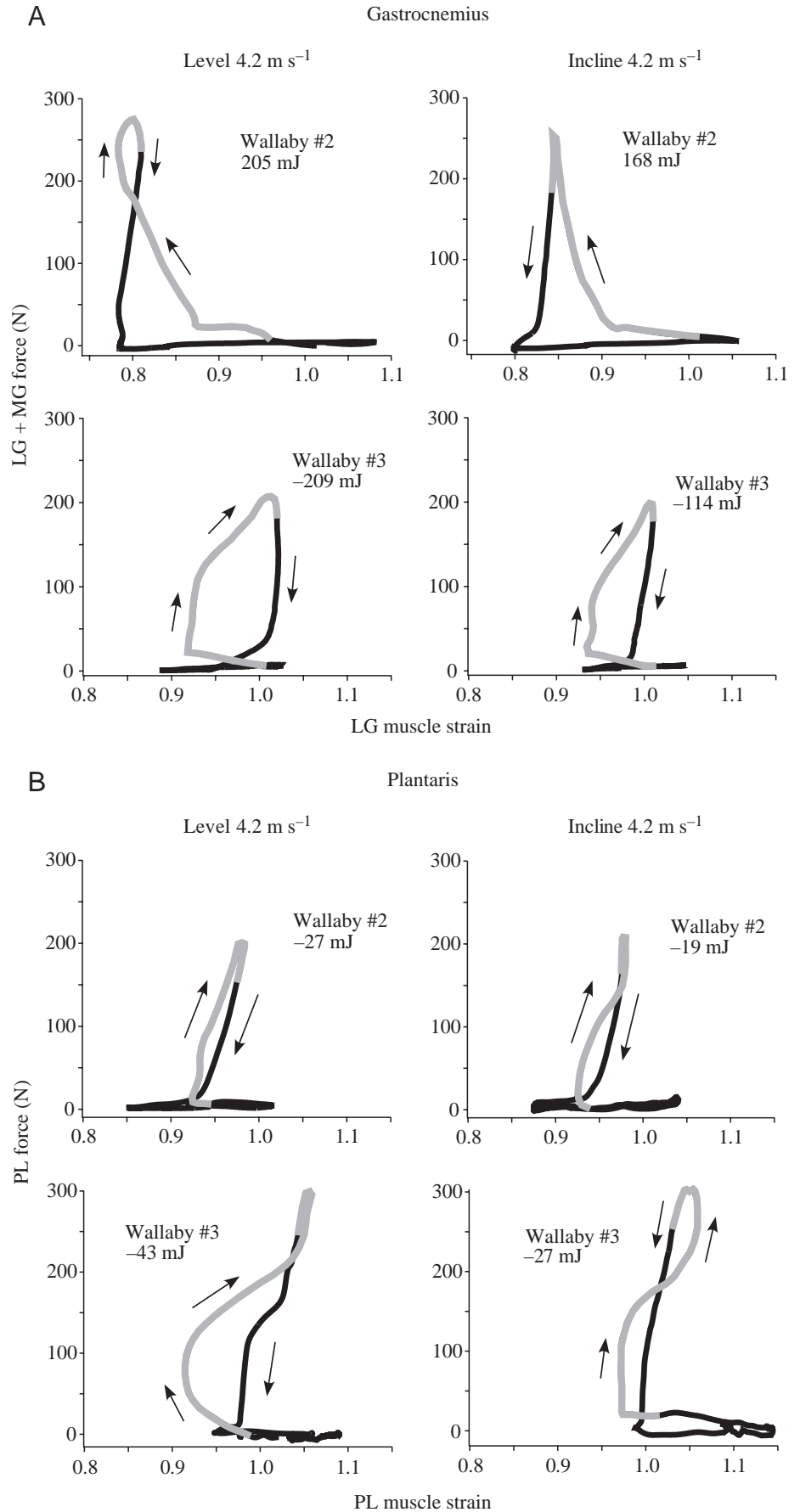

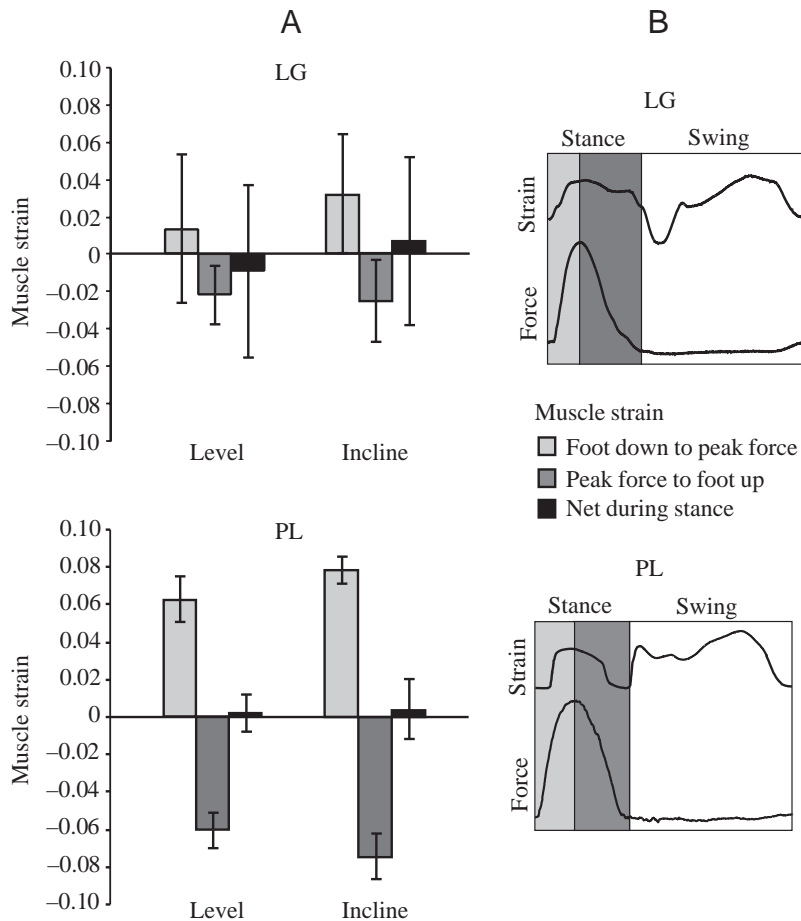

Fig. 5. (A) Histogram showing the mean ( $\pm$  S.E.M.) lengthening, shortening and net strains recorded from the four wallabies during level *versus* incline hopping (averaged for trials at  $3.3 \text{ m s}^{-1}$  and  $4.2 \text{ m s}^{-1}$ ). (B) Stance phase strains were measured over two intervals (based on level hopping recordings): from foot down to peak force and from peak force to foot off. Although the magnitude of lengthening and shortening strain was greater in the plantaris (PL) compared with the lateral gastrocnemius (LG), the net fascicle strains of the two muscles measured over the course of limb support were quite similar.

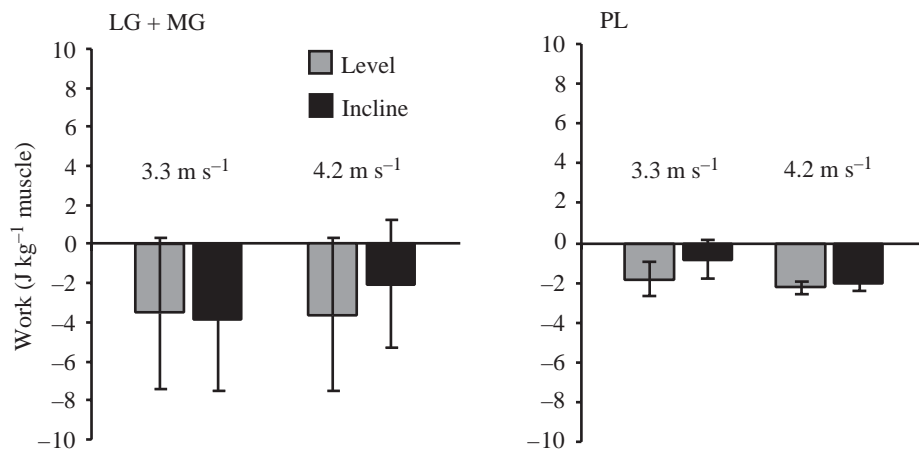

Fig. 6. Net mass-specific muscle work ( $\text{J kg}^{-1}$  muscle) performed by the gastrocnemius (LG + MG) and the plantaris (PL) during level *versus* incline hopping at  $3.3 \text{ m s}^{-1}$  and  $4.2 \text{ m s}^{-1}$ . Values are means  $\pm$  S.E.M. ( $N=4$ ).

level *versus* incline hopping (Fig. 6; Table 2). On average, both muscles absorbed net energy under both level and incline conditions, although the amount absorbed by the PL was trivially small. Assuming that the MG fascicles undergo the same length changes as the LG fascicles, the mass-specific work performed by the gastrocnemius as a whole amounted to  $-6.0 \text{ J kg}^{-1}$  muscle to  $-10.0 \text{ J kg}^{-1}$  muscle. For the PL, net mass-specific muscle work ranged from  $-1.4 \text{ J kg}^{-1}$  muscle to  $-2.0 \text{ J kg}^{-1}$  muscle.

#### Muscle and tendon stresses

Although muscle–tendon forces increased slightly with hopping speed, no consistent increase in muscle–tendon force (Table 2), and thus tendon stress (Fig. 7) and elastic energy savings (Table 2), occurred with a shift from level to incline hopping at either  $3.3 \text{ m s}^{-1}$  or  $4.2 \text{ m s}^{-1}$ . Whereas PL forces increased on an incline, LG forces decreased relative to level hopping (Table 2). Peak muscle stresses in the PL (mean,  $144 \text{ kPa}$ ) were slightly larger but generally similar in magnitude to those developed within the gastrocnemius (LG + MG mean =  $128 \text{ kPa}$ ). For the gastrocnemius, peak tendon stresses averaged  $25.2 \text{ MPa}$  for all conditions. For the PL, peak tendon stresses were of similar magnitude, averaging  $24.9 \text{ MPa}$  for all conditions. These stress levels indicate that both tendons operated with strains of  $\sim 2.5\%$ , yielding elastic energy savings for the gastrocnemius of  $0.43 \text{ J}$  on the level and  $0.36 \text{ J}$  on an incline. Elastic energy recovery by the PL tendon averaged  $0.46 \text{ J}$  on the level and  $0.55 \text{ J}$  on an incline. Consequently, tendon energy savings exceeded net muscle work by approximately threefold in the gastrocnemius and 20-fold in the PL.

#### Muscle activation patterns

Consistent with the similar contractile patterns of force and length change that were observed during level and incline hopping, we also observed uniform patterns in the timing of neural activation (EMG) relative to force development and fascicle strain (Fig. 8). Associated with its earlier development of force, activation of the LG occurred  $48 \pm 11 \text{ ms}$  (level) and  $50 \pm 16 \text{ ms}$  (incline) prior to limb contact, preceding PL EMG onset by  $29 \pm 6 \text{ ms}$  during level hopping and  $38 \pm 9 \text{ ms}$  during incline hopping. EMG onset



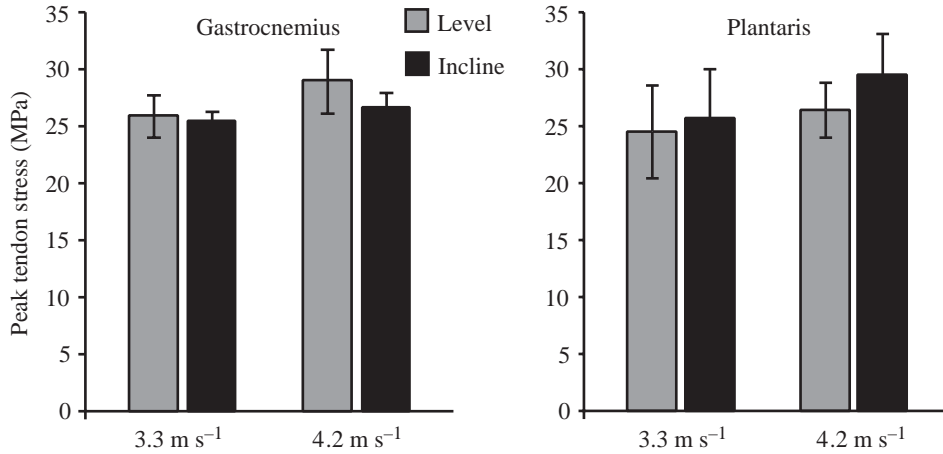

Fig. 7. Peak stresses (means  $\pm$  S.E.M.,  $N=4$ ) developed in the gastrocnemius and plantaris tendons during level *versus* incline hopping at 3.3 m s<sup>-1</sup> and 4.2 m s<sup>-1</sup>.

preceded force development by  $14\pm 5$  ms in the LG and  $17\pm 13$  ms in the PL for all conditions. In addition to deceleration of the foot, activation of both muscles prior to limb support probably corresponded to an initial series-elastic stretch of the muscle's aponeurosis and tendon (evidenced by fascicle shortening; Figs 2, 4), which are most compliant at low force levels. EMG offset occurred shortly after peak force

development in both muscles, lasting  $67\pm 5\%$  of the duration of force development by the LG and  $69\pm 7\%$  of the duration of force development by the PL. In both muscles, therefore, EMG offset occurred well before force declined to zero (Fig. 8).

Whereas no change in LG EMG phase and duration was observed, PL EMG phase and duration were modestly, but significantly, reduced during incline *versus* level hopping

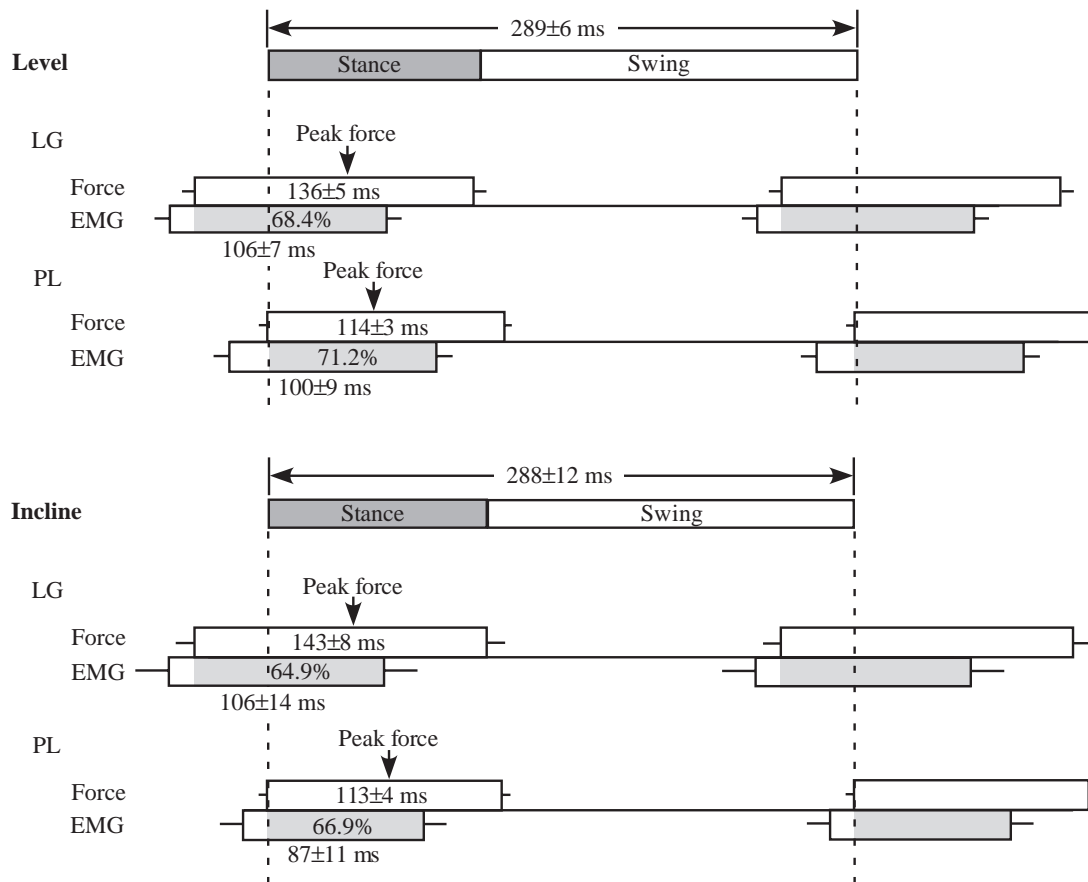

Fig. 8. Summary histogram showing the mean timing of force and EMG of the wallaby lateral gastrocnemius (LG) and plantaris (PL) muscles during level *versus* incline hopping. Because no significant timing differences were observed at 3.3 m s<sup>-1</sup> *versus* 4.2 m s<sup>-1</sup>, trials were pooled for these two speeds and averaged among the four animals. Error bars represent  $\pm 1$  S.E.M.

(Table 2). Correspondingly, normalized EMG intensity (mean spike amplitude) showed no change in the LG but was significantly increased in the PL when the animals hopped on an incline *versus* a level surface (Table 2). Nevertheless, the general uniformity of EMG timing relative to force development and the onset of stance during both level and incline hopping was consistent with the fact that stride frequency, limb contact time and duty factor did not change when the animals hopped on a level *versus* an incline at both speeds (Table 2). All three variables exhibited small, but significant, changes with speed; whereas duty factor [ $F_{(1,3)}=12.17$ ,  $P=0.007$ ] and limb contact time [ $F_{(1,3)}=96.79$ ,  $P=0.001$ ] decreased with speed, stride frequency increased slightly [ $F_{(1,3)}=27.41$ ,  $P=0.001$ ].

### Discussion

Our goal in this study was to determine whether the distal hind leg muscles of tammar wallabies, which are specialized for economical force generation and tendon energy savings during level hopping (Biewener et al., 1998), are capable of adjusting their contractile function to achieve increased shortening and net work production during incline hopping. This was motivated by a previous study of the contractile behavior of the turkey LG under level *versus* incline conditions. Although Roberts et al. (1997) observed such a shift in mechanical function of the turkey LG, we hypothesized that the ability of the distal leg muscles of tammar wallabies to do so may be constrained by their specialized design. Our results clearly support this hypothesis. We observed no significant change in net fascicle strain, force or net work in either the LG or PL muscles when tammar wallabies hopped at two different speeds on the level *versus* a 10° incline (17.4% grade). Whereas the gastrocnemius performed moderate negative work (−0.11 J to −0.13 J) during level *and* incline hopping, net work done by the PL was low (less than −0.06 J) for both conditions. Consistent with these findings, the timing of muscle activation relative to strain and force was also remarkably uniform.

Interestingly, in an earlier study, Griffiths (1989) found that the MG of thylogale wallabies (*Thylogale billardieri*) performs positive work when the animals accelerate from rest. Griffith's results were based on tendon buckle recordings similar to our own, but length measurements were based on indirect measures of joint kinematics and muscle–tendon moment arms. The length changes determined from these measurements are for the muscle–tendon unit as a whole, so it is difficult to quantify how much of the work was done by the muscle itself based on the work loop shown for when the animal accelerated (fig. 6 in Griffiths, 1989). Assuming that nearly all of the net shortening (15 mm) is due to fiber shortening (although this suggests nearly 100% shortening strain if the MG fibers are of similar length to the MG of a tammar wallaby; Biewener and Baudinette, 1995), this would suggest that the MG does ~25–30 J kg<sup>−1</sup> when a wallaby accelerates from rest. The uncertainty of such indirect

estimates of muscle fiber shortening makes it difficult to compare with our present findings. But it would be interesting to explore further whether acceleration from rest would enable the gastrocnemius and PL muscles to contribute substantial positive work to the animal's movement. We clearly did not observe such a shift in function for incline hopping at steady speed in tammar wallabies.

An important question to address is whether the net mechanical work performed by a wallaby hopping up a 10° incline requires much of an additional increase in limb muscle work and whether we should expect these two muscles to make a significant contribution to this work. The net positive mechanical power required for a 6.6 kg wallaby (mean mass of our four subjects) to raise its center of mass while hopping up a 10° slope at a speed of 4.2 m s<sup>−1</sup> is 47 W [=  $Mgu(\sin)\alpha=6.6\times9.81\times4.2\times\sin(10)$ , where  $g$  is gravitational acceleration and  $u$  is the animal's speed]. A stride frequency of 3.49 s<sup>−1</sup> (Table 2) means that 13.5 J of additional work is required per stride and 6.75 J of this extra work is performed by each limb. In comparison, the amount of energy that the muscles' tendons (including the MG) store and recover in each stride (0.91 J) is much less. For muscles that function to perform mechanical work, we might expect them to produce up to 30 J kg<sup>−1</sup> (Alexander, 1992). Given that the combined mass of the gastrocnemius (MG + LG) and PL muscles averages 0.062 kg, they might be capable of delivering as much as 1.86 J. In terms of maximal work, these muscles might therefore contribute as much as 28% of the total work required of the hind limb as a whole. In comparison, the mass of these three distal ankle extensors is 20.4% of the total mass of the hind limb muscle extensors per each limb as a whole (0.304 kg; C. McGowan, unpublished data). Thus, even though these muscles have the capacity to contribute a significant fraction of the muscle work required for incline hopping, and are of sufficient size to do so, our recordings indicate that they are not recruited to perform this role.

These results demonstrate that the energy-saving roles of the tammar wallaby LG and PL *via* force economy and tendon strain energy recovery are retained whether these animals hop over level ground or on an incline. In addition to retaining their spring-like behavior, neither muscle–tendon unit significantly altered the amount of force that each transmitted. Consequently, a similar level of stress and energy savings in both tendons was also maintained. In general, tendon elastic energy savings exceeded muscle work by 3–20-fold during both level and incline hopping. We have observed similar differences previously, with tendon energy savings exceeding muscle work by as much as 30-fold at faster hopping speeds (Biewener et al., 1998).

The uniformity of PL and LG muscle–tendon dynamics further reflects the overall uniformity of limb support dynamics; each wallaby's stride frequency, limb contact time and duty factor also remained the same under both level and incline conditions at a given speed. Consequently, any increase in metabolic cost with incline hopping, and at faster speeds on an incline, would most likely be due to an increase in the rate

of potential energy work that the animal must perform to raise its center of mass. Kram and Dawson (1998) reported a significant increase in metabolic rate with increased hopping speed on an incline for a single red kangaroo (*Macropus rufus*). Both red kangaroos (Dawson and Taylor, 1973) and tammar wallabies (Baudinette et al., 1992) are well known for their ability to hop at faster speeds on a level without increasing their metabolic rate. Therefore, our results here suggest that if tammar wallabies show a similar increase in metabolic rate while hopping on an incline, it is more likely due to the cost of potential energy work than to a reduction in the economy of muscle force generation or tendon energy recovery.

#### *Mechanical roles of proximal versus distal limb muscles*

Because muscle mass, fiber length and architecture differ among muscles operating at different joints within an animal's limb, it seems likely that other muscles may not function in the same way as the LG and PL muscles. It is possible that other distal hind leg muscles (e.g. the MG or flexor digitorum longus) may shorten more and contribute net work to raising the wallaby's center of mass during incline hopping, but we believe this is unlikely. Because the medial and lateral heads of the gastrocnemius are linked by a common aponeurosis and tendon and span the same joints (knee and ankle), it seems likely that the fascicles of the MG behave similarly to those in the LG. This was an assumption in our calculation of the combined work that the LG and MG performed. Nevertheless, measurements of MG fascicle behavior would be needed to confirm this. In addition, while it is possible that the flexor digitorum muscle contributes net work to incline hopping, we believe it is more likely that proximal knee and hip extensors perform the increased mechanical work needed to elevate the animal's center of mass on an incline. Recent studies of rats moving uphill and downhill on a treadmill over a range of speeds and gaits (Gillis and Biewener, 2002) show that knee and hip extensors alter their shortening behavior *in vivo* when they are active, in a manner that is consistent with the modulation of work production. In rats, the biceps femoris (BF) shortens more (from 16% to 21%), presumably doing more net work, when rats shift from level to incline locomotion (15°; Gillis and Biewener, 2002). Correspondingly, the vastus lateralis (VL) undergoes less net lengthening and presumably less energy absorption at the knee during level *versus* incline locomotion. Although initial lengthening of the rat VL is generally uniform, the amount of subsequent shortening strain varies with gait and grade, being greatest when the rats gallop and when they move uphill. Interestingly, rats also increase the stance duration and duty factor of their hind limb during incline *versus* level locomotion, in contrast to the absence of such changes observed here in tammar wallabies. Large active shortening strains (recorded in the semimembranosus of dogs; Gregersen et al., 1998) and analyses of joint work in goats (Pandy et al., 1988) and humans (Belli et al., 2002) also suggest that proximal limb muscles may play a greater role in work modulation than distal leg muscles. However, because of the likely transfer of work by biarticular muscles across the knee

to the ankle (van Ingen Schenau, 1990), interpretations of a proximo-distal 'division of labor' of muscle work drawn from studies of joint work alone are limited and must be viewed with caution. This may be offset, to some extent, when interpretations of muscle work are also based on patterns of muscle strain and EMG timing. Nevertheless, the absence of force measurements in more proximal muscles necessarily hinders an evaluation of whether a proximo-distal division of labor exists in terms of work modulation *versus* elastic energy savings. Additional study of proximal muscles and limb muscles of other species, as well as the development of improved methods for evaluating proximal muscle forces, is needed to better test the generality of this view.

Importantly, the results of Roberts et al. (1997) for the turkey LG show that specialization of muscle-tendon architecture *per se* may not limit a muscle's ability to contribute to changing demands of mechanical work. In part, this is because differences in muscle architecture alone do not favor differences in work performance. Although shorter fibered muscles favor increased energy economy because they can generate greater force per unit volume of muscle that is activated (Biewener and Roberts, 2000; Roberts et al., 1998), the increase in force is offset by the reduced length change for a given fiber strain, maintaining work and power output similar to that of a longer-fibered muscle. In a recent study of two distal leg muscles of guinea fowl (*Numida meleagris*), Daley and Biewener (2003) found that the LG and digital flexor (DF-IV) both increase their net shortening and work production when guinea fowl shift from level to incline (16°) running. However, assuming that all limb extensors do the same mass-specific work, the contribution of these two distal muscles to the animal's incline potential energy work was only one-third of that predicted for their mass. Consequently, these results also suggest that proximal limb muscles may play a greater role in modulating work to accommodate varying locomotor demands, such as changes in grade. Interestingly, the guinea fowl LG also contributed to work production (7.7 J kg<sup>-1</sup> muscle) during level running by shortening 10–15%, compared with nearly zero net work done by the DF-IV (Daley and Biewener, 2003). The basis for the difference in LG behavior compared with the turkey LG (Roberts et al., 1997) is unclear but may reflect differences in body size and underlying differences in leg stiffness associated with tendon stiffness and length, with guinea fowl having less stiff limbs and relatively longer and thinner uncalcified tendons.

Hence, in addition to muscle architecture, tendon geometry is also an important determinant of the mechanical role and contractile behavior of a muscle (Alexander, 1988; Biewener, 1998a; Ker et al., 1988). With long thin tendons, elastic energy saving is favored for a given level of force, but this also increases the series-elastic compliance against which a muscle's fibers must shorten to control length and limb and joint positions. Consequently, the pinnate design of distal leg muscles that attach to long tendons is well suited to elastic energy savings but less suited to positional control. By contracting under near isometric conditions, or over short

ranges of stretch followed by limited shortening, muscles can generate greater forces and therefore increase the economy of force generation, despite their role in work modulation being reduced. This is clearly the behavior that we observed here for two of the main hind leg muscle–tendon units of tammar wallabies. Even more extreme are the highly specialized fore- and hindlimb digital flexors of horses and other large ungulates (Biewener, 1998b; Dimery et al., 1986). The very short fibers of these muscles attach to such long tendons that they cannot possibly contribute meaningful work or length control (Biewener, 1997; Wilson et al., 2001). Recent measurements by Wilson et al. (2001) show that the retention of extremely short fibers in these muscles can contribute to viscous damping of potentially damaging or destabilizing limb vibrations, in addition to favoring elastic energy savings in the tendons.

*Neural activation in relation to contractile dynamics among muscle agonists*

Not surprisingly, the stereotypic contractile behavior of the tammar wallaby LG and PL resulted from generally uniform patterns of muscle activation during level *versus* incline locomotion. In both instances, activation and force development of the LG preceded the PL, occurring 48–50 ms prior to limb contact. Activation of the PL followed so that its force development began at the onset of limb support. The earlier activation of the LG is consistent with its role in decelerating the inertia of the foot and countering ankle flexion. Interestingly, the use of active muscle force to control foot inertia in wallabies is distinct from the role of passive muscle–tendon properties used by turkeys to decelerate their foot when running (Roberts et al., 1997). In addition to extending the ankle, the PL also serves as an agonist of the flexor digitorum muscle at the MP and phalangeal joints, which may explain its more delayed force development pattern (Biewener and Baudinette, 1995). Earlier activation of the LG also corresponds with the earlier and more substantial initial shortening strain of the muscle's fascicles compared with the PL. Even so, initial shortening at the onset of force development was observed in both muscles (Fig. 4) and is likely to reflect fascicle work done to stretch the muscles' aponeurosis and tendon when these are most compliant at low force levels (Bennett et al., 1986; Shadwick, 1990). This presumably increases the overall stiffness of the muscle–tendon unit, which allows for rapid force development (important for tendon elastic strain storage and recovery) once the foot is solidly in contact with the ground. Consistent with this interpretation, fascicle strains in the LG and PL were very small (<2%) once force development exceeded 33% of peak force (Fig. 4). As we have also observed in the rapidly contracting pectoralis muscle of birds during flight (Biewener et al., 1998; Dial and Biewener, 1993), activation of the wallaby LG and PL ends shortly after the muscle develops peak force. Much of force development therefore occurs after muscle stimulation has ended. This probably allows the muscle to relax by the end of limb support (or wing downstroke), avoiding unnecessary work to re-extend the muscle by its antagonist.

Changes in the relative phase of muscle activation are likely to be an important means by which muscle work is modulated. In contrast to our findings for the wallaby LG and PL, Roberts et al. (1997) found that activation of the turkey LG during uphill running was phase-advanced relative to the onset of limb support and showed evidence (based on integrated EMG) of increased muscle recruitment. This earlier activation was consistent with the increased shortening and work performed by the turkey LG during uphill running. Presumably such a shift in the timing of neural activation might also enable the tammar wallaby LG and PL to contribute useful muscle work during incline hopping, but this was not observed (indeed, the PL showed a reduced phase advance during incline hopping). Although more extreme grades might involve such a phase advance in neural activation, one reason why wallabies may not do this is the loss of force that would result from fascicle shortening. Such a loss (due to force–velocity effects) would necessarily require increased recruitment of these muscles, similar to that observed for the turkey LG. However, this would also incur a greater metabolic cost to generate the same level of force. Given that the magnitude of force did not change significantly during level *versus* incline hopping in these two muscles, increased shortening would necessarily have reduced their economy to generate comparable levels of force over the duration of limb support. Thus, it seems clear that more proximal muscles of the tammar wallaby must contribute the additional work required for incline hopping.

Varying muscle EMG patterns with respect to shifts in locomotor grade, presumably to modulate muscle work, have been observed in other species that have been studied. In rats, neural activation of the BF and VL did not shift temporally but increased intensity during incline *versus* level and decline running (Gillis and Biewener, 2002). Similar increases in EMG intensity (suggesting greater activation or increased recruitment volume) with incline locomotion have also been observed in cats (Buford and Smith, 1990) and horses (Robert et al., 2000), as well as in the turkey LG (Roberts et al., 1997). In guinea fowl, no significant shift in the activation of the LG and DF-IV with respect to uphill running was observed (Daley and Biewener, 2003). Whereas our results here for tammar wallabies showed no change in LG EMG phase, duration or intensity with a shift to incline hopping, we did observe a significant increase in EMG intensity relative to reductions in phase and duration in the PL. Consequently, it seems clear that varying patterns of neural activation of limb muscles are observed when animals change locomotor grade. Most generally, changes in motor recruitment are observed, but our results for wallabies show that such patterns may be absent or compensated for by an opposing shift in duration when changes in force and work output are minimal.

In summary, while there is evidence that distal muscle–tendon units are capable of contributing to work modulation by the limb as a whole (Roberts et al., 1997), it seems likely that, for at least some species, a 'division of labor' may exist among different muscle groups within the limb that is favorable in terms of metabolic energy expenditure. This



view, and our working hypothesis, holds that more proximal, longer-fibered muscles are better suited to length and work modulation, while more distal muscles favor energy savings by economical force development and tendon elastic storage. This is supported by our findings reported here for the distal leg muscles of tammar wallabies, as well as recent observations for a few proximal muscles in the hind limbs of other terrestrial vertebrate species. Even so, further work is needed to explore how contractile performance varies among different muscle groups and joints within the limb as a whole, particularly under varying conditions of locomotor performance that demand changes in muscle work and force.

The authors are indebted to Jayne Skinner for her superb assistance in caring for and handling the animals during experiments. We thank members of our lab groups, as well as two referees, for helpful comments on earlier drafts of this manuscript and are most appreciative of the four tammar wallabies that performed so well for us in these experiments. This work was supported by NSF grant IBN-9306793 (to A.A.B.) and ARC grant -A19943044 (to R.V.B.).

### References

- Alexander, R. McN.** (1988). *Elastic Mechanisms in Animal Movement*. Cambridge: Cambridge University Press.
- Alexander, R. McN.** (1992). The work that muscles can do. *Nature* **357**, 360-361.
- Baudinette, R. V., Snyder, G. K. and Frappell, P. B.** (1992). Energetic cost of locomotion in the tammar wallaby. *Am. J. Physiol.* **262**, R771-R778.
- Belli, A., Kyrolainen, H. and Komi, P. V.** (2002). Moment and power of lower limb joints in running. *Int. J. Sports Med.* **23**, 136-141.
- Bennett, M. B., Ker, R. F., Dimery, N. J. and Alexander, R. McN.** (1986). Mechanical properties of various mammalian tendons. *J. Zool. Lond.* **209**, 537-548.
- Biewener, A. A.** (1997). Optimization of musculoskeletal design. In *Optimization of Biological Design: Controversies in Symmorphosis* (ed. E. R. Weibel, C. R. Taylor and C. Bolis), pp. 70-77. Cambridge: Cambridge University Press.
- Biewener, A. A.** (1998a). Muscle function in vivo: the design of muscles used as springs versus muscles used to generate mechanical power. *Am. Zool.* **38**, 703-717.
- Biewener, A. A.** (1998b). Muscle-tendon stresses and elastic energy storage during locomotion in the horse. *Comp. Biochem. Physiol. B* **120**, 73-87.
- Biewener, A. A. and Baudinette, R. V.** (1995). *In vivo* muscle force and elastic energy storage during steady-speed hopping of tammar wallabies (*Macropus eugenii*). *J. Exp. Biol.* **198**, 1829-1841.
- Biewener, A. A. and Roberts, T. J.** (2000). Muscle and tendon contributions to force, work, and elastic energy savings: a comparative perspective. *Exer. Sport Sci. Rev.* **28**, 99-107.
- Biewener, A. A., Corning, W. R. and Tobalske, B. T.** (1998). *In vivo* pectoralis muscle force-length behavior during level flight in pigeons (*Columba livia*). *J. Exp. Biol.* **201**, 3293-3307.
- Buford, J. A. and Smith, J. L.** (1990). Adaptive control for backward quadrupedal walking. II. Hindlimb muscle synergies. *J. Neurophysiol.* **64**, 756-766.
- Daley, M. A. and Biewener, A. A.** (2003). Muscle force-length dynamics during level versus incline locomotion: a comparison of *in vivo* performance of two guinea fowl ankle extensors. *J. Exp. Biol.* **206**, 2941-2958.
- Dawson, T. J. and Taylor, C. R.** (1973). Energetic cost of locomotion in kangaroos. *Nature* **246**, 313-314.
- Dial, K. P. and Biewener, A. A.** (1993). Pectoralis muscle force and power output during different modes of flight in pigeons (*Columba livia*). *J. Exp. Biol.* **176**, 31-54.
- Dimery, N. J., Ker, R. J. and Alexander, R. McN.** (1986). Elastic properties of the feet of deer (Cervidae). *J. Zool. Lond.* **208**, 161-169.
- Gillis, G. B. and Biewener, A. A.** (2002). Effects of surface grade on proximal hindlimb muscle strain and activation during rat locomotion. *J. Appl. Physiol.* **93**, 1731-1743.
- Gregersen, C. S., Silverton, N. A. and Carrier, D. R.** (1998). External work and potential for elastic storage at the limb joints of running dogs. *J. Exp. Biol.* **201**, 3197-3210.
- Griffiths, R. I.** (1989). The mechanics of the medial gastrocnemius muscle in the freely hopping wallaby (*Thylogale billardierii*). *J. Exp. Biol.* **93**, 283-302.
- Ker, R. F.** (1981). Dynamic tensile properties of the plantaris tendon of sheep (*Ovis aries*). *J. Exp. Biol.* **93**, 283-302.
- Ker, R. F., Alexander, R. McN. and Bennett, M. B.** (1988). Why are mammalian tendons so thick? *J. Zool. Lond.* **216**, 309-324.
- Ker, R. F., Dimery, N. J. and Alexander, R. McN.** (1986). The role of tendon elasticity in hopping in a wallaby (*Macropus rufogriseus*). *J. Zool. Lond.* **208**, 417-428.
- Kram, R. and Dawson, T. J.** (1998). Energetics and biomechanics of locomotion by red kangaroos (*Macropus rufus*). *Comp. Biochem. Physiol. B* **120**, 41-49.
- Pandy, M. G., Kumar, V., Berme, N. and Waldron, K. J.** (1988). The dynamics of quadrupedal locomotion. *J. Biomech. Eng.* **110**, 230-237.
- Robert, C., Valette, J. P. and Denoix, J. M.** (2000). The effects of treadmill inclination and speed on the activity of two hindlimb muscles in trotting horses. *Equine Vet. J.* **32**, 312-317.
- Roberts, T. J., Kram, R., Weyand, P. G. and Taylor, C. R.** (1998). Energetics of bipedal running. I. Metabolic cost of generating force. *J. Exp. Biol.* **201**, 2745-2751.
- Roberts, T. J., Marsh, R. L., Weyand, P. G. and Taylor, C. R.** (1997). Muscular force in running turkeys: the economy of minimizing work. *Science* **275**, 1113-1115.
- Shadwick, R. E.** (1990). Elastic energy storage in tendons: mechanical differences related to function and age. *J. Appl. Physiol.* **68**, 1033-1040.
- van Ingen Schenau, G. J.** (1990). On the action of biarticular muscles, a review. *Neth. J. Zool.* **40**, 521-540.
- Wilson, A. M., McGuigan, M. P., Su, A. and van den Bogert, A. J.** (2001). Horses damp the spring in their step. *Nature* **414**, 895-899.