

MECHANISMS FOR GENERATING TEMPORAL FILTERS IN THE ELECTROSENSORY SYSTEM

GARY J. ROSE* AND ERIC S. FORTUNE

Department of Biology, University of Utah, Salt Lake City, UT 84112, USA

*e-mail: gary.rose@m.cc.utah.edu

Accepted 22 January; published on WWW 21 April 1999

Summary

Temporal patterns of sensory information are important cues in behaviors ranging from spatial analyses to communication. Neural representations of the temporal structure of sensory signals include fluctuations in the discharge rate of neurons over time (peripheral nervous system) and the differential level of activity in neurons tuned to particular temporal features (temporal filters in the central nervous system). This paper presents our current understanding of the mechanisms responsible for

the transformations between these representations in electric fish of the genus *Eigenmannia*. The roles of passive and active membrane properties of neurons, and frequency-dependent gain-control mechanisms are discussed.

Key words: electroreception, temporal filtering, neural code, amplification, gain control, plasticity, whole-cell patch, short-term depression, *Eigenmannia*.

Introduction

Selective behavioral responses to sensory stimuli require that filters pass biologically relevant information and reject inappropriate information. While features such as the spectral or chemical structure of a stimulus can be extracted to varying degrees by filters in peripheral receptor arrays, the temporal structure of these signals, e.g. the change over time in the amplitude, phase or spectral properties of the received signal, is represented non-selectively in the spatiotemporal patterns of activity in the periphery. Filters of temporal information in sensory signals must therefore reside in the central nervous system. Indeed, the transformation in coding the temporal structure of signals from a spatiotemporal pattern of activity in receptor arrays to a temporal filter representation in the central nervous system appears to be a general principle in sensory systems (Rose, 1986).

The mechanisms that underlie these transformations, however, are poorly understood. One reason for this lack of progress is that it has been exceedingly difficult, particularly in vertebrates, to make intracellular recordings *in vivo* from small sensory neurons in central nervous systems. With the exception of certain large neurons, experimenters have rarely been able to view the integration of subthreshold synaptic events in neurons that show temporal filtering properties. However, methods for using 'patch-type' pipettes to record intracellularly from neurons *in vivo* (Fig. 1) (Ferster and Jagadeesh, 1992; Rose and Fortune, 1996) have greatly facilitated the investigation of integrative processes in the central nervous system. In this paper, we present our recent advances, derived from 'whole-cell' intracellular recording, in identifying the mechanisms that underlie the filtering of

temporal patterns of input to the torus semicircularis (midbrain) in *Eigenmannia*. In addition, we summarize our current understanding of temporal filtering in the electrosensory system of fish of this genus.

Evidence for temporal filters in Eigenmannia

In its electrolocation behaviors, *Eigenmannia* selectively attends to slow modulations in the amplitude and phase of its electric organ discharges (EODs) (Bennett, 1971). Behavioral evidence for this filter comes from studies of the jamming avoidance response (JAR) (Watanabe and Takeda, 1963; Bullock et al., 1972; for reviews, see Heiligenberg, 1986, 1989, 1991). During the JAR, a fish changes its EOD frequency to minimize detrimental interference by a neighbor's EODs with its electrolocation abilities (Heiligenberg, 1973; Matsubara and Heiligenberg, 1978). This interference results from amplitude and phase modulations ('beats') that characterize the combination of these EODs. Modulation rates of approximately 3–8 Hz are most detrimental to the fish's electrolocation abilities and elicit the largest JARs (Bullock et al., 1972; Heiligenberg et al., 1978; Partridge et al., 1981; Bastian and Yuthas, 1984), whereas rates of 20 Hz or more have little effect. As a neural correlate of this behavior, most neurons in the torus semicircularis (midbrain) respond best to beat rates of approximately 2–6 Hz (Partridge et al., 1981) (Fig. 2). Other neurons in the torus respond more strongly to faster beat rates and, in many cases, respond well to brief cessations and frequency modulations of the EOD, such as occur in the communication signals that these fish use during reproductive behaviors (Hagedorn and Heiligenberg, 1985). In contrast,

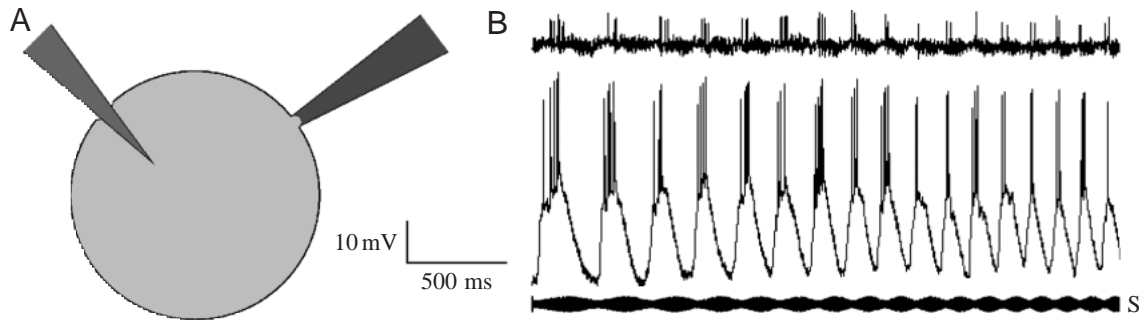

Fig. 1. (A) Conventional *versus* 'whole-cell' intracellular recording. Conventionally, a sharp micropipette (left electrode) is used to impale a neuron. In whole-cell intracellular recording, a high-resistance seal onto the cell membrane is formed by applying suction through a patch-type pipette (right electrode). The patch is then perforated to achieve an intracellular recording. (B) Sequential extracellular recording (top trace) and intracellular recording (middle trace) from a single neuron in the torus in response to the stimulus (S). Note the close correspondence in firing rate and pattern between extracellular and intracellular recordings. The amplitude envelope of the beating stimulus is nicely represented in the fluctuations of the membrane potential.

primary electrosensory afferents faithfully code (Gabbiani et al., 1996) beat rates up to at least 64 Hz in their periodicity of spikes (Bastian, 1981a), but do not show preferential responses for particular beat rates. The processes that underlie the generation of temporal filters in the torus are the subject of this paper.

Emergence of temporal filtering from the periphery to the midbrain

Weakly electric fish sense their EODs with 'tuberous' electroreceptors distributed over the body surface (Bullock, 1982). In addition, these fish possess 'ampullary' electroreceptors that are most sensitive to low-frequency electric fields. Primary electrosensory afferents project to the electrosensory lateral line lobe (ELL) in the medulla (Fig. 2). The ELL consists of three somatotopic maps of the tuberous receptor array (Heiligenberg and Dye, 1982) and a single map of the distribution of ampullary receptors. Modulations in the amplitude of a fish's EODs, such as those occurring in jamming situations or during electrolocation, are coded in the modulations of the spike rate of primary tuberous afferents. Each tuberous-type primary afferent trifurcates and distributes its information to each of the tuberous maps of the ELL. In general, ELL neurons are far more sensitive than primary afferents to the rate of change of signal amplitude (Bastian, 1981b; Gabbiani et al., 1996). Responses to steady-state levels of electrosensory signals, or slow changes in their amplitude, are greatly attenuated by descending gain-control feedback (Bastian, 1986a,b, 1995). This property appears to be particularly well developed in the lateral map, where many cells respond in a high-pass fashion, i.e. they respond well to fast beat rates but poorly to slow rates that are most effective in eliciting JARs. Most first-order neurons in the ELL, therefore, show little, if any, selectivity for these slow beat rates (Partridge et al., 1981; Shumway, 1989); exceptions are some 'I-units' (which respond to decreases in signal amplitude) in the centromedial map. Most neurons in the centromedial region show weak low-pass selectivity. Neurons

in the centrolateral map have response properties that are intermediate between those of the other two tuberous maps.

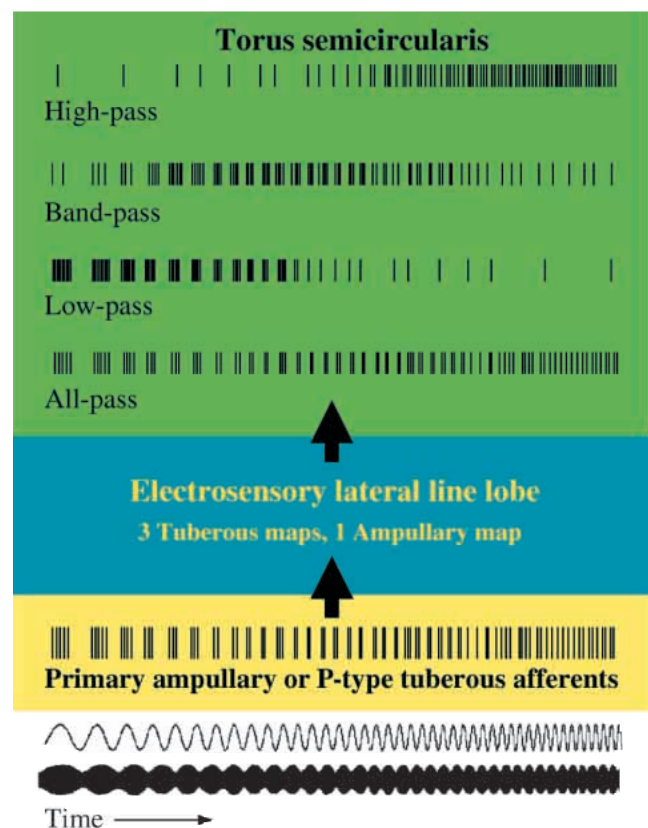

Fig. 2. Representation of the temporal structure of electrosensory signals in the firing of primary afferents and neurons in the torus semicircularis. Electrosensory stimuli are shown at the bottom. Ampullary cells respond to low-frequency electrical signals, P-type tuberous neurons respond to amplitude modulations found in beating signals. Note that primary afferents code the temporal structure of these stimuli in their periodicity of discharges (yellow box), whereas most neurons in the torus (green box) respond best over a particular range of temporal frequencies.

Pyramidal neurons in the three tuberous maps project to the torus to generate a single somatotopic map (Carr et al., 1981; Maler et al., 1982; for a review, see Carr and Maler, 1986). The torus is a midbrain structure that has 12 layers and approximately 48 cell types (Carr et al., 1981; Carr and Maler, 1985). Ampullary neurons project primarily to layers 2, 3 and 7 in the torus, whereas tuberous cells project primarily to layers 5 and 7 (Metzner and Heiligenberg, 1991; Rose and Call, 1992b).

In summary, the evidence suggests that the rejection of information concerning slow changes in signal amplitude (slow temporal frequencies), i.e. high-pass filtering, is well developed at the level of the ELL. Low-pass temporal filtering, however, does not appear to be well-developed at this level. Correspondingly, the strong selectivity of most neurons in the torus for beat rates that best elicit JARs, i.e. approximately 2–6 Hz, appears to be due largely to processes resident in this structure. In subsequent sections, we will present an overview of our current understanding of the mechanisms in the torus that contribute to the generation of filters that are sharply tuned to temporal frequencies in this behaviorally relevant range.

Temporal filtering mechanisms

The selectivities of toral neurons for particular temporal frequencies in electrosensory signals might result from four general types of process: (1) passive electrical filtering properties of particular neuron types; (2) voltage-dependent conductances that amplify responses to particular temporal frequencies; (3) frequency-dependent gain-control processes that might attenuate the responses of neurons to high temporal frequencies; and (4) selectivities already present in afferents to toral neurons. The roles of these processes were evaluated by employing the stimulation techniques shown in Fig. 3. Selectivity to sensory stimulation (Fig. 3A) was evaluated by applying signals through electrodes in the fish's mouth and at the tail, and/or through electrodes that surrounded the fish. The passive electrical filtering properties of cells were evaluated by injecting sinusoidal current into the soma (Fig. 3B). Filtering mechanisms upstream of the torus were identified by directly

stimulating afferents from the ELL (Fig. 3C); these include gain-control mechanisms. The contributions of each of these processes to the temporal filtering properties exhibited by toral neurons are discussed below.

Representation of temporal patterns of amplitude modulations: the decoding problem

A prelude to optimally utilizing passive electrical filtering mechanisms involves recovering an analog representation of the temporal structure of the stimulus. Amplitude modulations in electrosensory signals are coded by fluctuations in the probability of occurrence of spikes in 'P-type' primary afferents (Bullock, 1982). This representation permits information about the temporal structure of a stimulus to be transmitted between neurons located some distance apart, but how is this time-varying pattern of action potentials read, i.e. decoded (Bialek et al., 1991)? By averaging the spike activity of a cell over many repetitions of the stimulus, the amplitude structure of the stimulus can be estimated. The nervous system, however, must process information in real time. The decoding question can then be phrased as follows. Can this spike rate code be interpreted to recover an analog representation of the amplitude envelope of the stimulus? Following such recovery, relevant temporal information in a stimulus may be extracted, i.e. filtered, and less-meaningful information rejected (Rose and Call, 1992a).

To address this question, we made intracellular recordings from neurons in the torus semicircularis. We elected to record from the torus first because extracellular recordings have demonstrated that most neurons in the torus semicircularis respond selectively to beat rates that are most effective in eliciting the JAR (2–6 Hz) (Partridge et al., 1981). Because afferents from the electrosensory lateral line lobe primarily terminate in laminae 3–7 (Carr et al., 1981; Maler et al., 1982; for a review, see Carr and Maler, 1986), neurons in these layers were of particular interest.

Intracellular recordings revealed that the subthreshold fluctuations of the membrane potential of spiny neurons nicely reflected the amplitude envelope of a 'beating stimulus' (Fig. 4A) (Rose and Call, 1992a, 1993; Fortune and Rose,

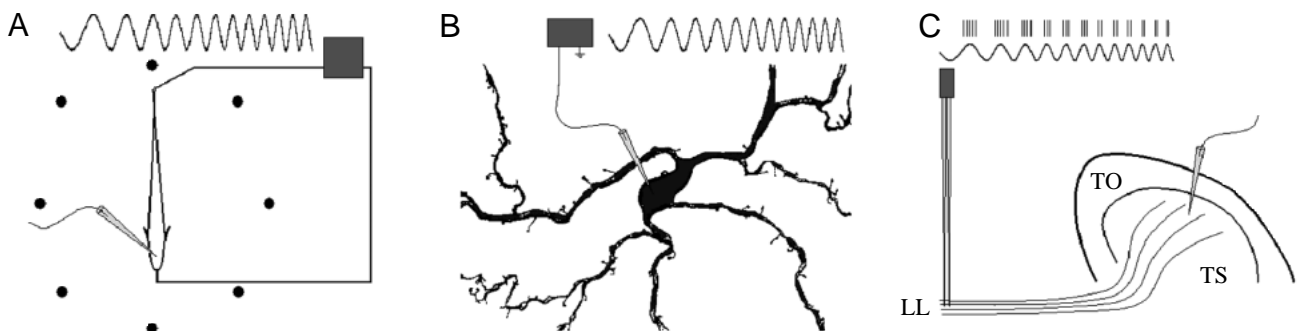

Fig. 3. Diagrams of modes of stimulation. (A) Electrical signals can be applied through an electrode located in the fish's mouth and another at the tail, and/or through electrode pairs external to the fish. (B) Current can be injected directly into neurons *via* the recording pipette. (C) Bipolar stimulation of the electrosensory afferents to torus neurons (TS); electrodes are placed in the lateral lemniscus (LL). The periodicity of groups of stimulation pulses mimics the temporal pattern of discharges of a nonselective afferent to a sensory stimulus. TO, tectum opticum.

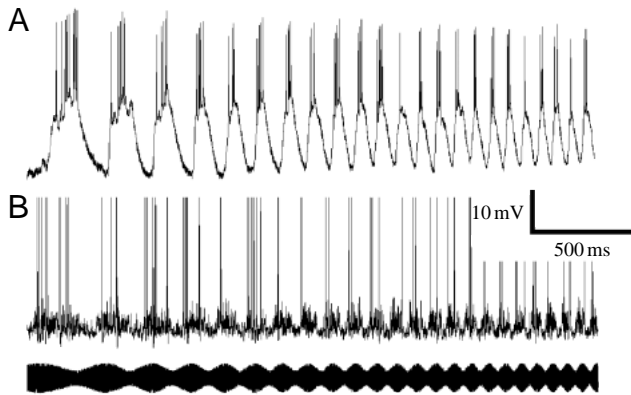

Fig. 4. Intracellular recordings of responses from a spiny neuron (A) and an aspiny neuron (B) as the beat rate of a sensory stimulus was changed from approximately 2 to 10 Hz. Note that the temporal structure (amplitude envelope) of the stimulus is nicely represented in the excitatory postsynaptic potentials of the spiny neuron.

1997a). These stimulus-related excitatory postsynaptic potentials (EPSPs) were generally largest for beat rates of approximately 2–8 Hz and triggered spikes, whereas their amplitude decreased markedly as the beat rate was increased to 20–30 Hz. For aspiny neurons, however, the amplitude envelope of the stimulus was not well represented in the membrane potential (Fig. 4B) (Rose and Call, 1992a; Fortune and Rose, 1997a). Instead, fast EPSPs were observed that varied in number over time in accordance with the amplitude envelope of the stimulus. In most cases, postsynaptic potential (PSP) amplitude in aspiny neurons remained constant or increased with stimulus beat rate. Because spiny and aspiny cells are found in the same lamina (Carr and Maler, 1985), these functional differences are unlikely to result entirely from different classes of afferents to these two neuron types.

Role of biophysical properties of neurons

The recovery of an analog representation of the amplitude envelope of stimuli might be functionally related to a process of passive electrical filtering by neurons. That is, the shape of EPSPs and their decline in amplitude as the stimulus beat rate is increased (from 2 to 30 Hz) might result, in part, from a long time constant of spiny neurons. The hypothesis that aspiny and spiny neurons differ in their passive electrical filtering properties was tested by injecting sinusoidal current (2–30 Hz) into electrosensory toral neurons (Fig. 3B) and recording the resulting depolarizations (Fortune and Rose, 1997a). These measurements were made primarily on neurons that did not show evidence of active membrane properties (discussed below) other than those associated with spike generation. Except in cases where spikes were rarely elicited by sensory stimuli, spiking was eliminated by slightly hyperpolarizing each neuron (–0.1 to –0.2 nA offset current); input resistance was constant at these levels, suggesting that inward rectifying conductances did not influence these measurements. Over this frequency range (2–30 Hz), spiny neurons showed low-pass electrical filtering, with a maximum decline in the amplitude

of voltage responses of 4–5 dB (Fortune and Rose, 1997a). Aspiny neurons, however, were all-pass over this range.

Because these intracellular recordings were performed *in vivo*, responses of neurons to current injection could be compared with responses to sensory stimulation. This comparison revealed that the magnitude of low-pass filtering could be as much as approximately 16 dB greater for sensory stimulation than for current injection. Thus, while these biophysical measurements support the hypothesis that the passive electrical filtering properties of spiny neurons contribute to their low-pass filtering of sensory information, they fail to account for the magnitude of the selectivity.

Role of voltage-dependent conductances

Voltage-dependent conductances amplify the responses of approximately one-third of toral neurons to particular beat rates (tuberous cells) or frequencies (ampullary) of sinusoidal signals. These conductances give rise to depolarizations of 10–20 mV that ride on top of EPSPs and are independent of those responsible for spike generation (Fortune and Rose, 1997a). For these neurons, increasing the level of negative current-clamp beyond a particular point results in an abrupt decrease in the amplitude of stimulus-related EPSPs; that is, the voltage-dependent, ‘all-or-none’ component drops out (Fig. 5). In many cases, hyperpolarization of the neuron by only 5–10 mV is sufficient to eliminate these all-or-none components of EPSPs. For neurons that do not exhibit evidence of prominent voltage-dependent conductances, other than those responsible for action potentials, PSP amplitude increases when the holding potential of the neuron is made more negative (Fig. 6).

All-or-none PSP components appear to fall into two classes: those with time courses that vary in concert with the temporal frequency of the stimulus (Fig. 5A), and those with short time courses that are largely independent of the temporal frequency of the stimulus (Fig. 5B). The first type amplify the low-pass filtering properties of neurons, whereas the latter type are found most commonly in high-pass or some band-pass cells. The activation and inactivation kinetics of voltage-gated channels probably govern the time course of the conductance changes that differentially amplify responses to particular temporal frequencies (Haag and Borst, 1996). Voltage-clamp studies should permit direct measurements of these conductances.

Role of gain-control processes

Neurons that do not show evidence of voltage-dependent conductances that amplify PSP amplitude still show, on average, approximately 6 dB more filtering for sensory stimulation than can be explained by their passive low-pass filtering properties. Further, in some neurons, PSP amplitude declined by as much as 20 dB when the temporal frequency of sensory stimulation was varied from 2 to 30 Hz. Potential sources of this unexplained filtering include (1) filtering properties already present in afferents and (2) frequency-dependent gain-control processes.

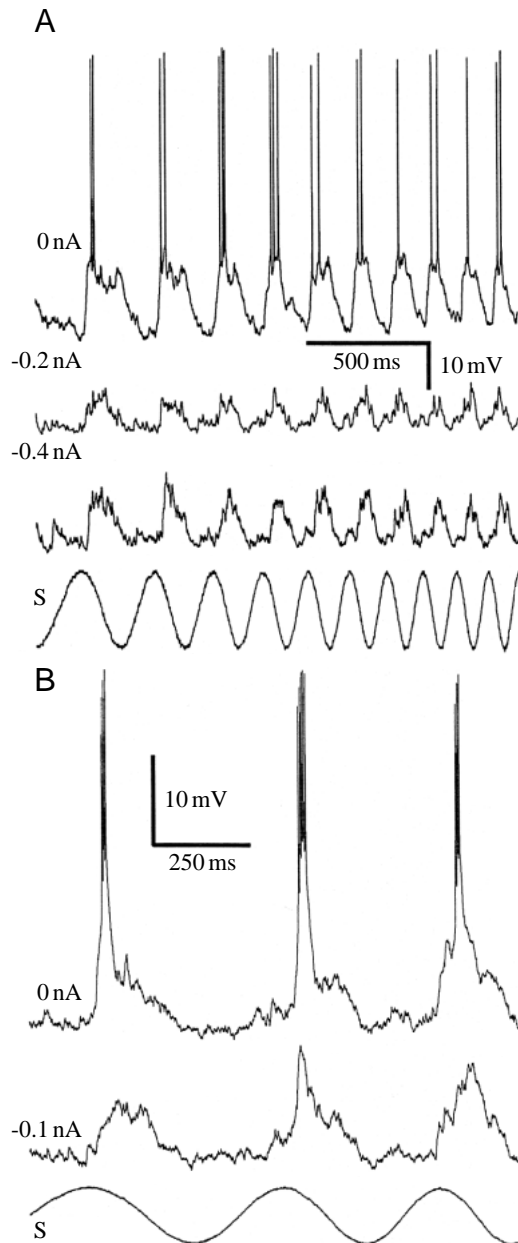

Fig. 5. Recordings from neurons with evidence of voltage-dependent conductances other than those associated with spike generation. (A) Neuron with evidence of a 'variable-duration' voltage-dependent conductance. Three time-aligned intracellular traces at different holding currents and the stimulus (S). (B) Recording from a neuron with evidence of a 'constant-duration' voltage-dependent conductance.

Preliminary results from direct electrical stimulation of toral afferents indicate that, in most cases, PSP amplitude decreases by a similar amount as for sensory stimulation when the temporal pattern of direct electrical stimulation mimics the firing pattern of a nonselective afferent. Thus, the marked low-pass filtering properties of toral neurons appear to result, in most cases, primarily from local mechanisms and minimally from the response properties of ELL afferents.

Alternatively, filtering might be a dynamic process in which gain-control mechanisms differentially attenuate PSP amplitude depending on the temporal frequency of inputs. In this model, gain-control processes would occur primarily when stimuli of fast temporal frequencies are received, thereby attenuating the steady-state responses of neurons to these stimuli. Preliminary work suggests that gain-control mechanisms contribute substantially to the steady-state temporal filtering properties of toral neurons. The magnitude of frequency-dependent gain-control processes is determined by measuring the amplitude of PSPs during the beginning and end segments of sensory stimulus 'bursts' (Fig. 7B). The beat rate, i.e. temporal frequency, of the stimulus is held constant during each burst. For temporal frequencies of 20–30 Hz, but not frequencies of 5 Hz, PSP amplitude decreases, in some cells by as much as 12 dB over 1 s of stimulation. The amplitudes of PSPs in response to the last few beat cycles in these bursts are quite similar to those measured at points in the sensory scan where the beat rate is of the same value. PSP amplitude at the beginning of sensory bursts generally falls off with beat rate in accordance with that predicted from the passive electrical filtering properties of the neuron.

To determine whether this frequency-dependent gain-control process occurs in the torus, the lateral lemniscus was stimulated with volleys of pulses (bipolar stimulation, Fig. 3C); the interval rate, but not the total number of pulses, was varied. When the periodicity of afferent stimulation was below approximately 5 Hz, PSP amplitude was relatively constant. At higher volley rates, however, PSP amplitude declined markedly over time (Fig. 7D). Direct electrical stimulation of toral afferents indicates, therefore, that this frequency-dependent gain-control process occurs within the torus, not at the preceding stage of electrosensory processing (ELL).

Interestingly, neurons that respond poorly to slow temporal frequencies of sensory stimulation generally show, for direct afferent stimulation, the largest PSPs in response to pulse train periodicities of approximately 2 Hz. That is, these high-pass and band-pass cells generally show all-pass or low-pass, respectively, responses to direct electrical stimulation of toral afferents. Mechanisms for attenuating responses to the slow temporal frequencies of sensory stimulation appear, therefore, to reside upstream of the torus. Indeed, Bastian (1986a,b, 1995) has shown that a negative-feedback loop from the *n. praeeminentialis* to the ELL mediates a gain-control process that may attenuate responses to slow temporal frequencies in sensory signals.

Discussion

The emergence of filters for the temporal structure of electrosensory signals is shown in Fig. 8. Temporal variations in the amplitude of electrosensory signals are coded in the temporal fluctuations of the probability of discharge of peripheral nerve fibers; mean spike rate is, however, largely independent of the temporal frequency of the stimulus (denoted

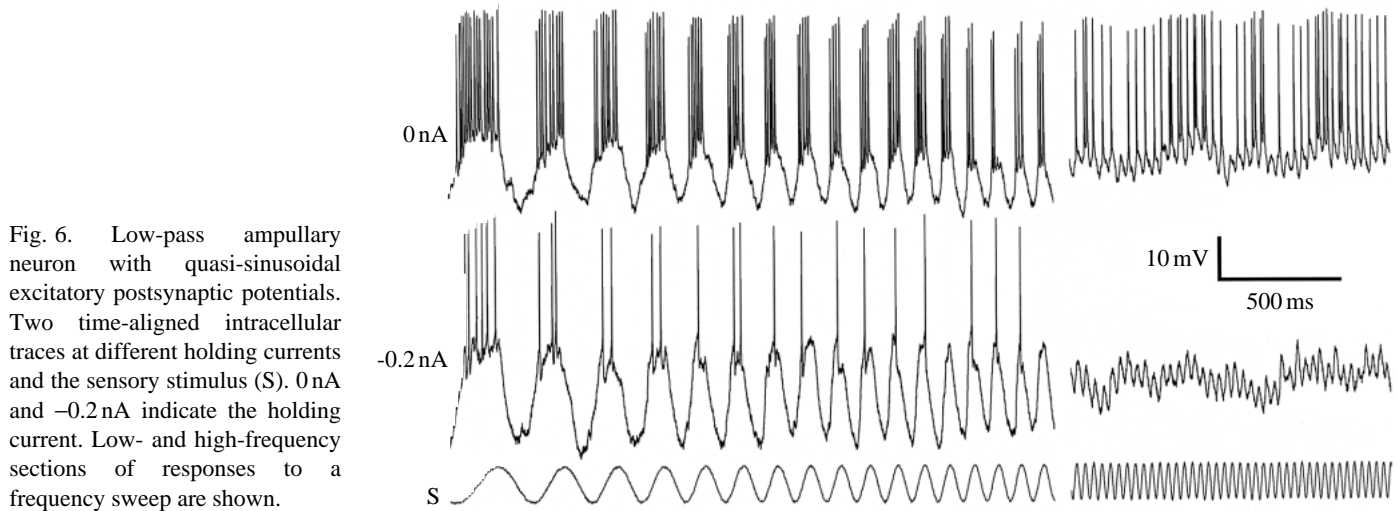

Fig. 6. Low-pass ampullary neuron with quasi-sinusoidal excitatory postsynaptic potentials. Two time-aligned intracellular traces at different holding currents and the sensory stimulus (S). 0 nA and -0.2 nA indicate the holding current. Low- and high-frequency sections of responses to a frequency sweep are shown.

by a uniform gray shading of the bar). Evidence of filtering of these temporal patterns of information is first seen in the ELL. Differentiation into low-pass, band-pass and high-pass filters begins at this level. At the torus, the selectivity of neurons for low, mid or high temporal frequencies is strongly enhanced over that seen at the ELL.

The goal of understanding the mechanisms that underlie this

transformation is partially complete. The selective responses of neurons in the torus for particular beat rates appear to result from both network and cellular properties. In all but a small fraction (apparently less than 10%) of cells, their low-pass properties appear to be generated primarily in the torus. Exceptions to this rule are 'I-type' neurons. Some I-type units respond poorly to fast temporal frequencies of sensory

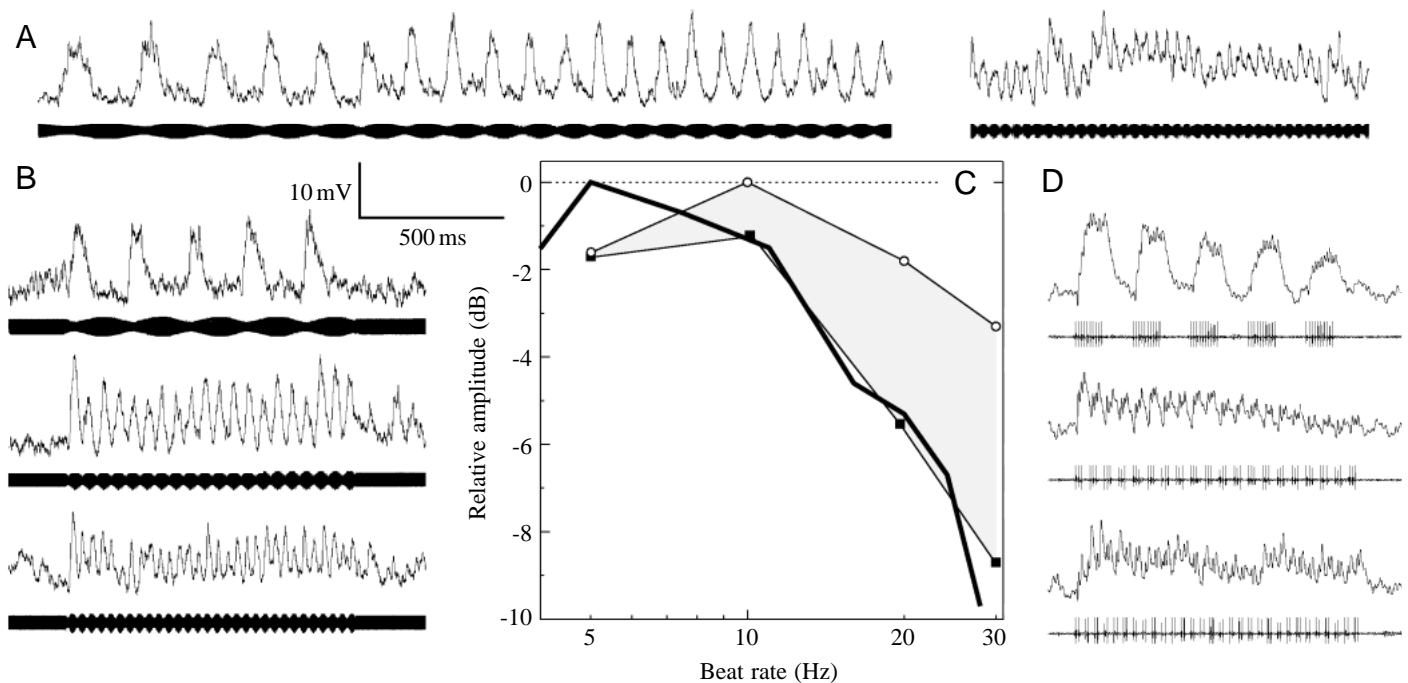

Fig. 7. Role of frequency-dependent gain-control processes in temporal filtering. Intracellular recordings were made from a single neuron in the torus while the following stimulus regimens were employed. The beat rate of a sensory stimulus was either varied linearly from 2 to 30 Hz (A) or held at 5, 20 or 30 Hz (sensory bursts) for 1 s (B); responses to the beginning and end of the sensory scan are shown. Afferents to toral neurons were activated directly by bipolar stimulation of the lateral lemniscus. As in the case of sensory stimulation, the temporal pattern of stimulation varied from 2 to 30 Hz (not shown) or was delivered in bursts (D) 1 s in duration; the periodicity of the stimulation volleys was held constant at 5, 20 or 30 Hz. (C) The relative amplitudes of postsynaptic potentials in response to the sensory scan (thick line) and the beginning (open circles) and end (filled squares) of sensory bursts are plotted as a function of the temporal frequency of stimulation, up to 30 Hz; low-pass filtering due to gain control is indicated by shading. Holding currents of approximately -0.1 to -0.2 nA were used to eliminate spiking.

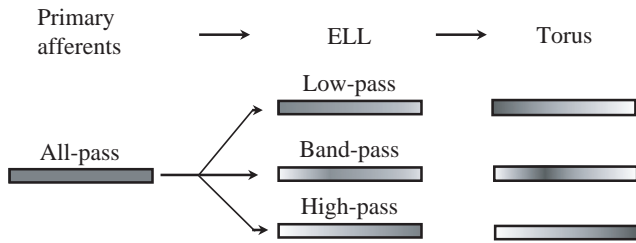

Fig. 8. Summary of the emergence of temporal filters in the electrosensory system of *Eigenmannia*. The shading of the bars reflects response strength as a function of the temporal frequency (2–30 Hz) of the sensory stimulus; stronger responses are shown as darker shading. Note that selectivity in response to low, mid or high temporal frequencies is first seen in the electrosensory lateral line lobe (ELL) and is well developed in the torus; selective attenuation of responses to high temporal frequencies occurs predominantly in the torus.

stimulation, e.g. scans or bursts, but respond more vigorously to fast temporal patterns of stimulation of their electrosensory afferents (lateral lemniscus). The data, therefore, suggest that these cells receive input from ELL neurons that already show significant low-pass filtering. Correspondingly, Shumway (1989) has found that some I-type cells in the centromedial map of the ELL show low-pass responses to time-varying sensory stimuli. The mechanisms underlying the low-pass temporal selectivity of these ELL neurons is unknown.

Gain-control processes associated with negative feedback from the n. praeminentialis, via the cerebellum, to the ELL (Bastian, 1986a,b, 1995) appear to attenuate responses of first-order central neurons to very slow changes in signal amplitude. This component of the feedback system appears to influence most prominently the response properties of neurons in the lateral map of the ELL and, therefore, contributes to the high-pass selectivity of these ELL neurons. Further amplification of responses to high temporal frequencies (>30 Hz) appears to be generated by Na⁺ channels in the proximal dendrites and soma of pyramidal neurons (Turner et al., 1994). High-pass selectivity is then conveyed to some cells in the torus.

In the torus, cellular properties, such as the acquisition of

synaptic inputs through dendritic spines, passive electrical filtering and amplification via voltage-dependent conductances, play important roles in attenuating or amplifying particular temporal patterns of inputs to a neuron (Fig. 9). Gain-control processes in the torus limit the responses of low- and band-pass neurons to fast temporal frequencies in sensory signals. This frequency-dependent gain-control process may be mediated by local circuit actions, by cellular properties or by both. The remaining low-pass filtering may be due to the selectivity of ELL neurons. This selectivity may result from descending feedback from the torus, via the n. praeminentialis, or mechanisms resident in the ELL (Turner et al., 1996). Facilitating excitatory feedback from the torus, through the n. praeminentialis, may act via both *N*-methyl-D-aspartate (NMDA) and non-NMDA receptors (Berman et al., 1997).

While much progress has been made in understanding the mechanisms that underlie the filtering of temporal patterns in the electrosensory system, many additional questions remain. First, the precise role(s) of dendritic spines in the computational properties of toral neurons, for example, is still unclear. Electrosensory neurons that code the amplitude envelope of beating signals (tuberosus) or the waveform of low-frequency sinusoidal signals (ampullary) are heavily spined (Rose and Call, 1992a, 1993; Fortune and Rose, 1997a,b). Anatomical studies have shown that spiny neurons receive most of their synaptic input onto the spines (Peters et al., 1991). It appears that individual inputs to the dendritic spines of electrosensory neurons contribute little to the depolarization of the soma. Resistance to current flow into the cell may result from the properties of ligand-gated channels at the synapse, the resistance of the spine stem or a combination of both. In hippocampal pyramidal neurons, the former properties are most likely to limit the maximum conductance in response to individual inputs (Harris and Stevens, 1989); only in long, slender spines is the stem expected appreciably to limit current flow. With regard to temporal filtering, acquisition of inputs through dendritic spines may permit a large number of inputs to a neuron, such that the amplitude of the stimulus at any instant can be estimated accurately by the average temporal density of inputs. In this hypothesis, the fidelity of representing

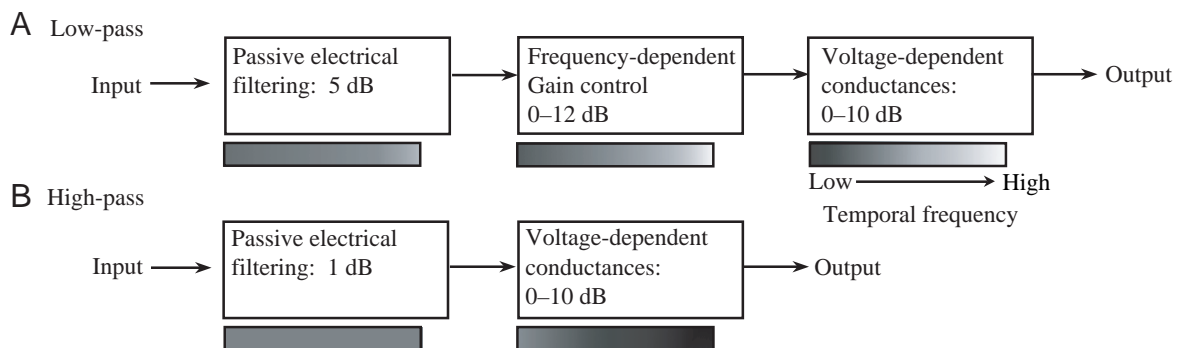

Fig. 9. Summary of processes that contribute to the temporal filtering properties of neurons in the torus. These processes either attenuate or amplify the responses of neurons to particular temporal frequencies of stimulation over the range 2–30 Hz. This attenuation or amplification is denoted by the shading of the bars; stronger responses are shown as darker shading.

the temporal structure of the stimulus in the time course of membrane depolarizations (EPSPs), as well as the magnitude of these depolarizations, can be regulated by the number and synaptic conductance of spines that are present on individual neurons. The idea that individual neurons might adaptively regulate their synaptic input by up- or down-regulating spine density and morphology is supported by evidence that, *in vitro*, neurons respond to pharmacological blockade of particular postsynaptic receptors by increasing their spine density (Rocha and Sur, 1995; Papa and Segal, 1996).

Second, dendritic spines may increase the membrane surface area of neurons and thereby increase their capacitance. Because aspiny and spiny neurons in the torus have similar input resistances (Fortune and Rose, 1997a), this increased capacitance probably accounts for the stronger low-pass electrical filtering characteristics of spiny neurons. Accordingly, a positive correlation between spine density and low-pass temporal filtering has been observed for toral neurons (Rose and Call, 1992a, 1993).

Theoretical and experimental work has also suggested that dendritic spines may function as compartments in which local concentrations of second messengers and channel properties might differ from those in other regions of a neuron (Yuste and Denk, 1995; Eilers et al., 1995; Segal, 1995; Jaffe and Brown, 1997). In addition to influencing the passive electrical filtering properties of neurons, therefore, dendritic spines may modulate EPSP amplitude and time course *via* active processes. It is presently unclear whether voltage- or second-messenger-gated channels at the spine heads contribute to the amplification of EPSP amplitude that we have observed in some toral neurons. Further, little is known about the types of voltage-gated channels that are involved and the ions that carry the current. Future work, using pharmacological blockers of particular channel types, should clarify the nature of these conductances.

Finally, the mechanisms that underlie frequency-dependent gain control are unknown. This process is a form of plasticity (short-term synaptic depression); over time, information about fast temporal frequencies is attenuated, i.e. PSP amplitude decreases. This form of gain control appears to occur in the torus, although it is unclear whether it is due to processes at the particular cell that is recorded, to presynaptic terminals or to local circuit actions. Injection of current directly into the cell shows that this gain-control process is not activated simply by appropriate temporal fluctuations in the membrane potential of the soma. Experiments *in vitro* may help to clarify the nature of this mechanism of plasticity.

This research was supported by grants from the National Science Foundation and a postdoctoral fellowship from NIH.

References

Bastian, J. (1981a). Electrolocation. I. How the electroreceptors of *Apteronotus albifrons* code for moving objects and other electrical stimuli. *J. Comp. Physiol.* **144**, 465–479.

- Bastian, J.** (1981b). Electrolocation. II. The effects of moving objects and other electrical stimuli on the activities of two categories of posterior lateral line lobe cells in *Apteronotus albifrons*. *J. Comp. Physiol.* **144**, 481–494.
- Bastian, J.** (1986a). Gain control in the electrosensory system mediated by descending inputs to the electrosensory lateral line lobe. *J. Neurosci.* **6**, 553–562.
- Bastian, J.** (1986b). Gain control in the electrosensory system: a role for the descending projections to the electrosensory lateral line lobe. *J. Comp. Physiol.* **158**, 505–515.
- Bastian, J.** (1995). Electrolocation. In *The Handbook of Brain Theory and Neural Networks* (ed M. A. Arbib), pp. 352–356. Cambridge, MA: The MIT Press.
- Bastian, J. and Yuthas, J.** (1984). The jamming avoidance response of *Eigenmannia*: Properties of a diencephalic link between sensory processing and motor output. *J. Comp. Physiol.* **154**, 895–908.
- Bennett, M. V. L.** (1971). Electric organs. In *Fish Physiology* (ed. W. S. Hoar and D. J. Randall), pp. 493–574. New York: Academic Press.
- Berman, N. J., Plant, J., Turner, R. W. and Maler, L.** (1997). Excitatory amino acid receptors at a feedback pathway in the electrosensory system: Implications for the searchlight hypothesis. *J. Neurophysiol.* **78**, 1869–1881.
- Bialek, W., Rieke, F., De Ruyter van Steveninck, R. R. and Warland, D.** (1991). Reading a neural code. *Science* **252**, 1854–1856.
- Bullock, T. H.** (1982). Electroreception. *Annu. Rev. Neurosci.* **5**, 121–170.
- Bullock, T. H., Hamstra, R. H. and Scheich, H.** (1972). The jamming avoidance response of high-frequency electric fish, I and II. *J. Comp. Physiol.* **77**, 1–48.
- Carr, C. E. and Maler, L.** (1985). A Golgi study of the cell types of the dorsal torus semicircularis of the electric fish *Eigenmannia*: Functional and morphological diversity in the midbrain. *J. Comp. Neurol.* **235**, 207–240.
- Carr, C. E. and Maler, L.** (1986). Electroreception in gymnotiform fish: Central anatomy and physiology. In *Electroreception* (ed. T. H. Bullock and W. Heiligenberg), pp. 319–374. New York: Wiley & Sons.
- Carr, C. E., Maler, L., Heiligenberg, W. and Sas, E.** (1981). Laminar organization of the afferent and efferent systems of the torus semicircularis of gymnotiform fish: Morphological substrates for parallel processing in the electrosensory system. *J. Comp. Neurol.* **203**, 649–670.
- Denk, W., Sugimori, M. and Llinas, R.** (1995). Two types of calcium response limited to single spines in cerebellar Purkinje cells. *Proc. Natl. Acad. Sci. USA* **92**, 8279–8282.
- Eilers, J., Augustine, G. J. and Konnerth, A.** (1995). Subthreshold synaptic Ca^{2+} signalling in fine dendrites and spines of cerebellar Purkinje neurons. *Nature* **373**, 155–158.
- Ferster, D. and Jagadeesh, B.** (1992). EPSP–IPSP interactions in cat visual cortex studied with *in vivo* whole-cell patch recording. *J. Neurosci.* **12**, 1262–1274.
- Fortune, E. S. and Rose, G. J.** (1997a). Passive and active membrane properties contribute to the temporal filtering properties of midbrain neurons *in vivo*. *J. Neurosci.* **17**, 3815–3825.
- Fortune, E. S. and Rose, G. J.** (1997b). Temporal filtering properties of ampullary electrosensory neurons in the torus semicircularis of *Eigenmannia*: evolutionary and computational implications. *Brain Behav. Evol.* **49**, 312–323.
- Gabbiani, F., Metzner, W., Wessel, R. and Koch, C.** (1996). From

- stimulus encoding to feature extraction in weakly electric fish. *Nature* **384**, 564–567.
- Haag, J. and Borst, A.** (1996). Amplification of high-frequency synaptic inputs by active dendritic membrane processes. *Nature* **379**, 639–641.
- Hagedorn, M. and Heiligenberg, W.** (1985). Court and spark: Electric signals in the courtship and mating of gymnotoid electric fish. *Anim. Behav.* **33**, 254–265.
- Harris, K. M. and Stevens, J. K.** (1989). Dendritic spines of CA1 pyramidal cells in the rat hippocampus: serial electron microscopy with reference to their biophysical characteristics. *J. Neurosci.* **9**, 2982–2997.
- Heiligenberg, W.** (1973). Electrolocation of objects in the electric fish *Eigenmannia* (Rhamphichthyidae, Gymnotoidei). *J. Comp. Physiol.* **87**, 137–164.
- Heiligenberg, W.** (1986). Jamming avoidance responses, model systems for neuroethology. In *Electroreception* (ed. T. H. Bullock and W. Heiligenberg), pp. 613–649. New York: Wiley & Sons.
- Heiligenberg, W.** (1989). Central processing of electrosensory information in gymnotiform fish. *J. Exp. Biol.* **146**, 255–275.
- Heiligenberg, W.** (1991). *Neural Nets in Electric Fish*. Cambridge, MA: MIT Press.
- Heiligenberg, W., Baker, C. and Matsubara, J.** (1978). The jamming avoidance response in *Eigenmannia* revisited: The structure of a neuronal democracy. *J. Comp. Physiol.* **127**, 267–286.
- Heiligenberg, W. and Dye, J. C.** (1982). Labelling of electroreceptive afferents in gymnotoid fish by intracellular injection of HRP: The mystery of multiple maps. *J. Comp. Physiol.* **148**, 287–296.
- Jaffe, D. B. and Brown, T. H.** (1997). Calcium dynamics in thorny excrescences of CA3 pyramidal neurons. *J. Neurophysiol.* **78**, 10–18.
- Maler, L., Sas, E., Carr, C. E. and Matsubara, J.** (1982). Efferent projections of the posterior lateral line lobe in gymnotiform fish. *J. Comp. Neurol.* **211**, 154–164.
- Matsubara, J. and Heiligenberg, W.** (1978). How well do electric fish electrolocate under jamming? *J. Comp. Physiol.* **149**, 339–351.
- Metzner, W. and Heiligenberg, W.** (1991). The coding of signals in the electric communication of the gymnotiform fish *Eigenmannia*: From electroreceptors to neurons in the torus semicircularis. *J. Comp. Physiol.* **169**, 135–150.
- Papa, M. and Segal, M.** (1996). Morphological plasticity in dendritic spines of cultured hippocampal neurons. *Neurosci.* **71**, 1005–1011.
- Partridge, B. L., Heiligenberg, W. and Matsubara, J.** (1981). The neural basis of a sensory filter in the jamming avoidance response: No grandmother cells in sight. *J. Comp. Physiol.* **145**, 153–168.
- Peters, A., Palay, S. L. and Webster, H. D.** (1991). *The Fine Structure of the Nervous System*, pp. 82–96. New York: Oxford University Press.
- Rocha, M. and Sur, M.** (1995). Rapid acquisition of dendritic spines by visual thalamic neurons after blockade of *N*-methyl-D-aspartate receptors. *Proc. Natl. Acad. Sci. USA* **92**, 8026–8030.
- Rose, G.** (1986). A temporal processing mechanism for all species? *Brain Behav. Evol.* **28**, 134–144.
- Rose, G. J. and Call, S. J.** (1992a). Evidence for the role of dendritic spines in the temporal filtering properties of neurons: The decoding problem and beyond. *Proc. Natl. Acad. Sci. USA* **89**, 9662–9665.
- Rose, G. J. and Call, S. J.** (1992b). Differential distribution of ampullary and tuberosus processing in the torus semicircularis of *Eigenmannia*. *J. Comp. Physiol.* **170**, 253–261.
- Rose, G. J. and Call, S. J.** (1993). Temporal filtering properties of midbrain neurons in an electric fish: Implications for the function of dendritic spines. *J. Neurosci.* **13**, 1178–1189.
- Rose, G. J. and Fortune, E. S.** (1996). New techniques for making whole-cell recordings from CNS neurons *in vivo*. *Neurosci. Res.* **26**, 89–94.
- Segal, M.** (1995). Imaging of calcium variations in living dendritic spines of cultured rat hippocampal neurons. *J. Physiol., Lond.* **486**, 283–295.
- Shumway, C. A.** (1989). Multiple electrosensory maps in the medulla of weakly electric gymnotiform fish. I. Physiological differences. *J. Neurosci.* **9**, 4388–4399.
- Turner, R. W., Maler, L., Deerinck, T., Levinson, R. S. and Ellisman, M. H.** (1994). TTX-sensitive dendritic sodium channels underlie oscillatory discharge in a vertebrate sensory neuron. *J. Neurosci.* **14**, 6453–6471.
- Turner, R. W., Plant, J. R. and Maler, L.** (1996). Oscillatory and burst discharge across electrosensory topographic maps. *J. Neurophysiol.* **76**, 2364–2382.
- Watanabe, A. and Takeda, K.** (1963). The change of discharge frequency by A.C. stimulus in a weakly electric fish. *J. Exp. Biol.* **40**, 57–66.
- Yuste, R. and Denk, W.** (1995). Dendritic spines as basic functional units of neuronal integration. *Nature* **375**, 682–684.