

EFFECTS OF DILUTED NATURAL WATER AND ALTERED IONIC ENVIRONMENTS ON GUSTATORY RESPONSES IN RAINBOW TROUT (*ONCORHYNCHUS MYKISS*)

YASUYUKI KITADA* AND TOSHIAKI J. HARA†

Department of Fisheries and Oceans, Freshwater Institute, Winnipeg, Manitoba, Canada R3T 2N6

Accepted 1 September 1993

Summary

1. The effects of adaptation to diluted natural water (NW) and various salt solutions on the gustatory responses recorded from the palatine nerve in rainbow trout (*Oncorhynchus mykiss*) were studied.

2. The magnitude of the response to 1 mmol l^{-1} L-proline (L-Pro) decreased when the perfusing NW was diluted with artificial fresh water (AFW) that maintained concentrations of major cations. AFW suppressed the responses to L-Pro by about 70 %.

3. The responses to 1 mmol l^{-1} L-Pro, 0.1 mmol l^{-1} quinine-HCl (Q-HCl) and 10 nmol l^{-1} taurothocholic acid (TLCA) were eliminated or reduced (to <10 %) by adapting the palate to distilled water (DW). The addition of $0.1\text{--}100 \text{ mmol l}^{-1}$ salts (NaCl, KCl, CaCl₂, MgCl₂) and choline chloride restored the gustatory responses to about 50 % of those in NW. The addition of salts to NW had no effect on the gustatory responses.

4. The gustatory responses to 5 % CO₂ were similarly reduced when the palate was adapted to solutions that contained no NW (DW, AFW, 10 mmol l^{-1} NaCl in DW). However, the reduction was independent of salt concentration, suggesting a different transduction mechanism for CO₂.

4. Tetrodotoxin ($1 \mu\text{mol l}^{-1}$) had no effect on the gustatory responses to L-Pro.

5. We conclude that NW is required and that cations alone are not sufficient to support maximal gustatory responses. The results suggest that an unknown substance(s) contained in NW plays an essential role in gustatory reception and that permeation of cations through the apical membrane of gustatory cells is not involved in gustatory transduction in rainbow trout.

Introduction

The apical processes of the gustatory cells in fishes are exposed directly to natural water, although their surfaces are usually covered with the thin cap of mucus secreted by

*Present address: Department of Physiology, Okayama University Dental School, Okayama 700, Japan.

†To whom correspondence should be addressed.

Key words: rainbow trout, *Oncorhynchus mykiss*, taste, electrophysiology, palatine nerve, amino acids, bile salts, transduction.

the supporting cells (Jakubowski and Whitear, 1990; Reutter, 1992). Thus, changes in water quality due to rainfall, melting snow and anthropogenic activities could affect the functional characteristics of the gustatory system (see Klaprat *et al.* 1992). In contrast, mammalian gustatory cells are normally covered with saliva, which plays an important role in gustation, acting as an ion reservoir (Matsuo and Yamamoto, 1992). It is generally accepted that the adsorption of chemical stimuli on the microvillar membranes of gustatory cells induces the receptor potential (Beidler, 1971). In the eel (*Anguilla japonica*), gustatory receptor cations in the external solution support the gustatory responses to amino acids, and binding of the cations to the receptor membrane plays an essential role in gustatory reception (Yoshii and Kurihara, 1983). Recently, L-arginine-activated (Teeter *et al.* 1990) and L-proline-activated (Kumazawa *et al.* 1990) cation channels on the apical membrane of the gustatory cells in the catfish (*Ictalurus punctatus*) have been proposed. Besides cations, natural water contains various inorganic and organic substances which may be involved in gustatory reception in fishes.

To test this possibility, we examined the effects of diluted natural water and altered ionic environments on the gustatory responses in rainbow trout (*Oncorhynchus mykiss*). Extensive electrophysiological investigations have pinpointed specific and potent gustatory stimuli for rainbow trout, including amino acids, bile salts and CO₂ (Marui *et al.* 1983; Yamamori *et al.* 1988; Yamashita *et al.* 1989; Hara *et al.* 1993; Hara, 1993). Our data indicate that an unknown substance(s) in natural water plays an important role in gustatory reception and that external ions alone are not sufficient to support maximal gustatory responses in rainbow trout.

Materials and methods

Experimental animals

Rainbow trout, *Oncorhynchus mykiss* (Walbaum), 18–23 cm in standard length, were obtained from the Rockwood Aquaculture Research Centre, Freshwater Institute. Fish were held in laboratory tanks supplied with flowing, aerated, dechlorinated Winnipeg city water (11.5–12.5 °C) which contained the following concentrations of major ion: 0.51 mmol l⁻¹ Ca²⁺, 0.24 mmol l⁻¹ Mg²⁺, 0.14 mmol l⁻¹ Cl⁻, 0.08 mmol l⁻¹ Na⁺ and 0.04 mmol l⁻¹ K⁺. Hardness was equivalent to 0.75 mmol l⁻¹ CaCO₃ (75.1 mg l⁻¹) (Wagemann *et al.* 1987). The average pH of the water was 7.7 (range 7.64–7.80) (Brown *et al.* 1984). Dissolved inorganic carbon measured by gas chromatography (Stainton *et al.* 1974) was 1.43±0.04 mmol l⁻¹ (mean ± S.E.M.).

Electrical recording of gustatory responses

Gustatory responses were recorded from the palatine nerve (VIIth cranial nerve) innervating taste buds located on the palate and inside the upper lip using the method of Marui *et al.* (1983). The fish were anaesthetized with MS222 (tricaine methanesulphonate, 1:8000), immobilized with an intramuscular injection of Flaxedil (gallamine triethiodide, 5 mg kg⁻¹ body mass) and positioned in an acrylic trough with natural water (NW) (dechlorinated Winnipeg city water) perfusing the gills. The eyeball

was removed to expose the palatine nerve running through the bottom of the eye socket. The nerve bundle was cut off centrally and its peripheral end was hooked on bipolar platinum–iridium electrodes. Throughout surgery, MS222 (1:8000) was continuously metered into the water perfusing the gills. Mineral oil was added to the orbit to prevent drying of the nerve preparation during recording. The neural activity of the whole nerve bundle was amplified (Grass 7P511), integrated (time constant 0.5 s) and recorded on a pen recorder (Grass 7B polygraph). The response magnitude was measured as the height of integrated responses over a stimulus duration of 5 s. Consistent responses were generally obtained 5 min after the onset of perfusion with adapting solutions (see Fig. 3). Each stimulus was tested 3–4 times consecutively with a standard interval of 2 min during the period from 5 to 11 min after perfusion started. The mean response obtained was expressed as a percentage of responses to respective gustatory stimuli dissolved in NW (control response) before adaptation. Statistical significance was assessed using Student's *t*-test.

Stimulus delivery and perfusion

The apparatus used to deliver stimulant and perfusing solutions to the palate is shown in Fig. 1. A bottle containing an adapting solution was placed in a raised waterbath providing a constant temperature (11.5–12.5 °C) and pressure head. A constant volume (2 ml) of stimulant solution was drawn into a disposable glass pipette and placed in a water jacket. To avoid contamination, distilled water (DW), instead of NW, at 11.5–12.5 °C was led into the water jacket to maintain the test solution at constant temperature. In all experiments, the palate was first acclimated to NW and a standard response to 1 mmol l⁻¹ L-proline (L-Pro) established. After the introduction of the adapting solution, a stimulant prepared in the respective adapting solution was applied to the palate at a flow rate of 0.2 ml s⁻¹ for 5 s.

Adapting and test solutions

Adapting solutions used were as follows: DW with or without 1 mmol l⁻¹ NaHCO₃; artificial fresh water (AFW); NW diluted with DW; NW diluted with AFW; 0.1–100 mmol l⁻¹ salt solutions prepared with DW (NaCl, KCl, MgCl₂, MgSO₄, CaCl₂, sodium acetate and choline chloride) and sucrose; and the same salt solutions prepared with NW. The composition of AFW based on chemical analyses of Winnipeg water was 0.08 mmol l⁻¹ NaCl, 0.04 mmol l⁻¹ KCl, 0.51 mmol l⁻¹ CaCl₂ and 0.24 mmol l⁻¹ MgCl₂. Dilution of NW with AFW maintained the concentrations of major cations. The ionic compositions of all adapting solutions are listed in Table 1. All salts and sucrose were of the highest purity available from commercial sources. Gustatory stimulant solutions employed were 1 mmol l⁻¹ L-Pro, 0.1 mmol l⁻¹ quinine–HCl (Q-HCl), 10 nmol l⁻¹ tauroolithocholic acid (TLCA) (all from Sigma Chemical, MO) and 5 % CO₂. The gustatory receptors of rainbow trout are highly sensitive to these chemicals (Marui *et al.* 1983; Hara *et al.* 1984; Yamashita *et al.* 1989). Treatment with tetrodotoxin (TTX; Sigma Chemical) was carried out by perfusing the palate with a 1 μmol l⁻¹ solution for 5 min. Responses before, during and after treatment were compared.

Table 1. Ionic composition of adapting solutions

| | Na ⁺ | K ⁺ | Ca ²⁺ | Mg ²⁺ | Choline | Cl ⁻ | SO ₄ ²⁻ | Acetate | Sucrose |
|-----------------------|-----------------|----------------|------------------|------------------|---------|-----------------|-------------------------------|---------|---------|
| NW | 0.08 | 0.04 | 0.51 | 0.24 | - | 0.14 | - | - | - |
| AFW | 0.08 | 0.04 | 0.51 | 0.24 | - | 1.62 | - | - | - |
| 80% NW+20% DW | 0.064 | 0.032 | 0.41 | 0.19 | - | 0.11 | - | - | - |
| 50% NW+50% DW | 0.04 | 0.02 | 0.26 | 0.12 | - | 0.07 | - | - | - |
| 20% NW+80% DW | 0.016 | 0.008 | 0.1 | 0.048 | - | 0.028 | - | - | - |
| 10% NW+90% DW | 0.008 | 0.004 | 0.051 | 0.024 | - | 0.014 | - | - | - |
| 5% NW+95% DW | 0.004 | 0.002 | 0.026 | 0.012 | - | 0.007 | - | - | - |
| 20% NW+80% AFW | 0.08 | 0.04 | 0.51 | 0.24 | - | 1.32 | - | - | - |
| 10% NW+90% AFW | 0.08 | 0.04 | 0.51 | 0.24 | - | 1.47 | - | - | - |
| 5% NW+95% AFW | 0.08 | 0.04 | 0.51 | 0.24 | - | 1.55 | - | - | - |
| NaCl-DW | 0.1-100 | - | - | - | - | 0.1-100 | - | - | - |
| Sodium acetate-DW | 10 | - | - | - | - | - | - | 10 | - |
| KCl-DW | - | 0.1-100 | - | - | - | 0.1-100 | - | - | - |
| CaCl ₂ -DW | - | - | 0.1-10 | - | - | 0.2-20 | - | - | - |
| MgCl ₂ -DW | - | - | - | 0.1-100 | - | 0.2-200 | - | - | - |
| MgSO ₄ -DW | - | - | - | 10 | - | - | 10 | - | - |
| Choline chloride-DW | - | - | - | - | 0.1-100 | 0.1-100 | - | - | - |
| Sucrose-DW | - | - | - | - | - | - | - | - | 2-200 |
| NaCl-NW | 0.18-100 | 0.04 | 0.51 | 0.24 | - | 0.24-100 | - | - | - |
| KCl-NW | 0.08 | 1-10 | 0.51 | 0.24 | - | 1.1-10.1 | - | - | - |
| CaCl ₂ -NW | 0.08 | 0.04 | 0.61-10.5 | 0.24 | - | 0.34-20.1 | - | - | - |
| MgCl ₂ -NW | 0.08 | 0.04 | 0.51 | 1.24-10.2 | - | 2.1-20.1 | - | - | - |
| MgSO ₄ -NW | 0.08 | 0.04 | 0.51 | 10.24 | - | 0.14 | 10 | - | - |
| Sucrose-NW | 0.08 | 0.04 | 0.51 | 0.24 | - | 0.14 | - | - | 200 |

Concentrations are in mmol l⁻¹.

NW, natural water; AFW, artificial fresh water; DW, distilled water.

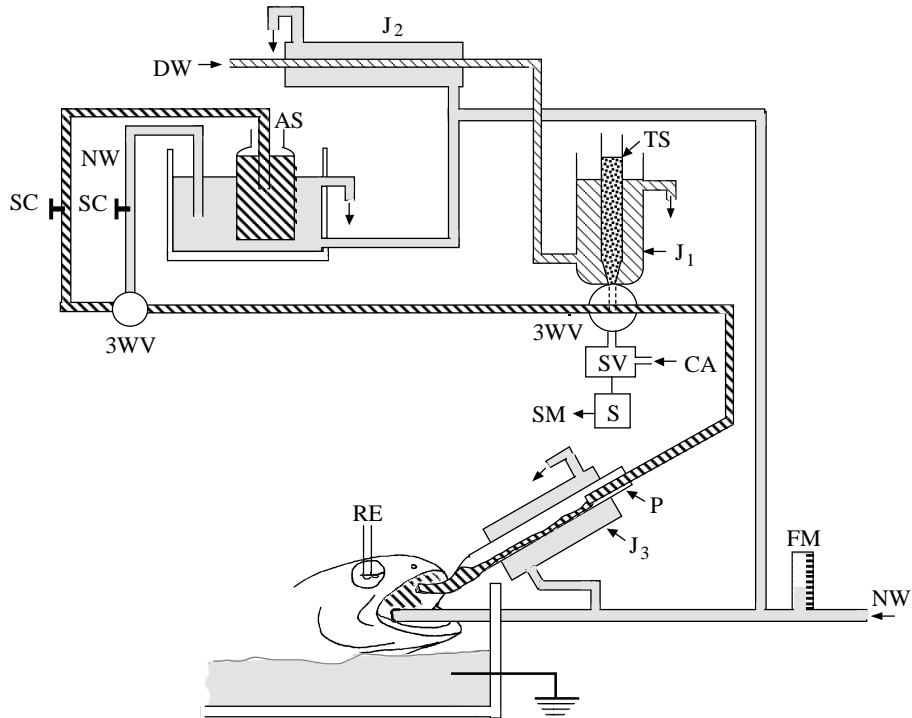

Fig. 1. Experimental set-up for recording gustatory responses and perfusion system. AS, adapting solution; DW, distilled water; TS, test solution; NW, natural water; J₁, J₂ and J₃, water jackets; FM, flow meter; SC, screw cock; 3WV, three-way valve; SV, solenoid valve; CA, compressed air; S, time switch; SM, signal marker; P, pipette; RE, recording electrode.

Results

Characteristics of palatine nerve responses

Stimulation of the palate and the inside upper lip with 1 mmol l^{-1} L-Pro dissolved in NW elicited a large response from the palatine nerve (Fig. 2). The response to L-Pro was rapidly adapting and quickly returned to the baseline level of activity, even with continued stimulation. The response characteristics to all gustatory stimuli were similar, although responses to TLCA were generally sustained by continued stimulation.

Effects of DW, AFW and diluted NW on gustatory responses to L-Pro

When the palate was irrigated with DW, responses to L-Pro (dissolved in DW) were almost eliminated after 5 min of adaptation (Fig. 2A). The responses recovered to the original level 5–10 min after the preparation was returned to NW. DW buffered with 1 mmol l^{-1} NaHCO_3 (pH 7.8–7.9) had similar effects (data not shown). Adaptation to AFW induced a slight L-Pro response (approx. 15% of the control response) (Fig. 2B). NW was diluted with either DW or AFW. Temporal responses to 1 mmol l^{-1} L-Pro following adaptation to NW diluted with DW and AFW are shown in Fig. 3. The magnitude of the response to L-Pro gradually declined and attained a steady level

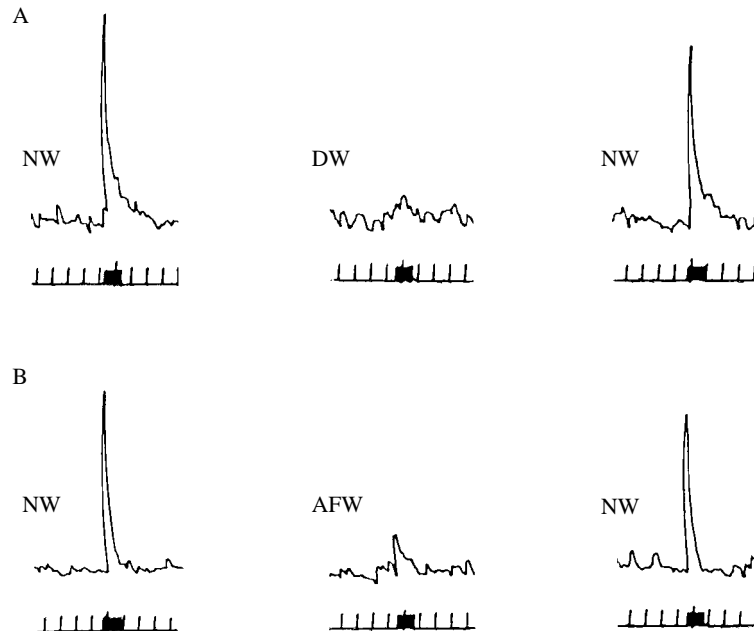

Fig. 2. Effects of adaptation to distilled water (DW) and artificial fresh water (AFW) on gustatory responses to 1 mmol l^{-1} L-proline (L-Pro) of the palatine nerve of rainbow trout. Left-hand traces in A and B, integrated responses to L-Pro in natural water (NW) during perfusion of the palate with NW. Middle traces show (A) integrated responses to L-Pro in DW and (B) integrated responses to L-Pro in AFW. Right-hand records in A and B show integrated responses to L-Pro after returning to perfusion with NW. A and B were obtained from different preparations. Each division of the time signal marks 5 s.

6–7 min after the onset of perfusion with DW-diluted NW (Fig. 3A). The magnitude of the response decreased with increasing dilution, reaching less than 10% of the control value with DW alone. Effects of dilution with AFW were similar to those of DW dilution, but the magnitude of the response attained a steady level within 5 min (Fig. 3B). In the ensuing experiments, the steady response levels obtained after 5 min of adaptation were employed (also see Materials and methods). Fig. 4 shows magnitudes of responses to 1 mmol l^{-1} L-Pro as a function of the percentage dilution of NW with DW and AFW. There was no significant difference in the response magnitude between DW and AFW dilutions; for example, responses to L-Pro in 5% NW+95% DW and 5% NW+95% AFW were $11.0 \pm 6.8\%$ (mean \pm S.E.M.) and $15.5 \pm 2.0\%$, respectively ($P > 0.5$).

Effects of electrolyte and non-electrolytes on responses to L-proline

Adaptation to DW almost eliminated the response to L-Pro (see Fig. 2). However, the responses were partially restored by adding various concentrations of salts to the perfusing DW. Adaptation to 10–100 mmol l^{-1} mono- and divalent chlorides (NaCl, KCl,

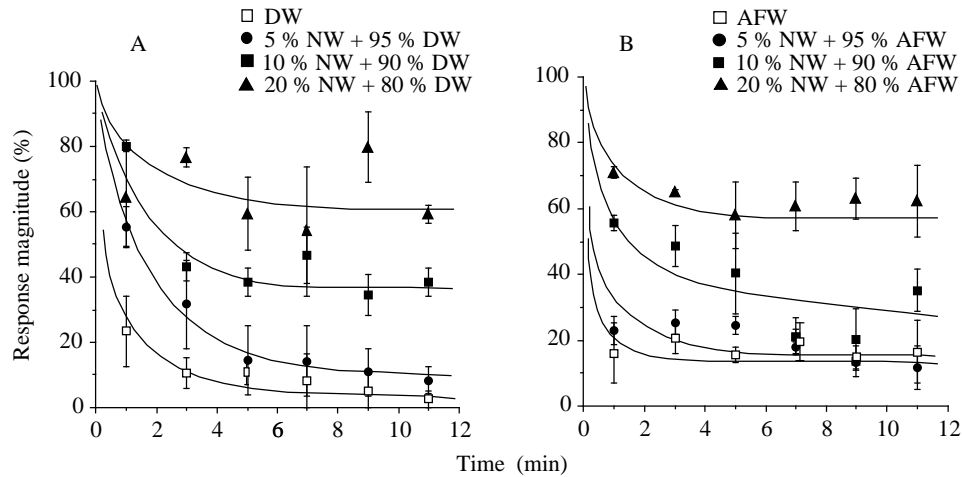

Fig. 3. Temporal decline of gustatory responses to 1 mmol l^{-1} L-proline (L-Pro) after adaptation to (A) natural water (NW) diluted with distilled water (DW) and (B) natural water (NW) diluted with artificial fresh water (AFW). Responses to 1 mmol l^{-1} L-Pro in NW (control response) were obtained during perfusion of the palate with NW. In this and following graphs, average ($N=3$ preparations) response magnitude is presented as a percentage of the control response magnitude. Vertical bars represent S.E.M. The abscissa represents time after onset of perfusion with adapting solutions. Curves drawn in this and the following figures were fitted to the points by eye.

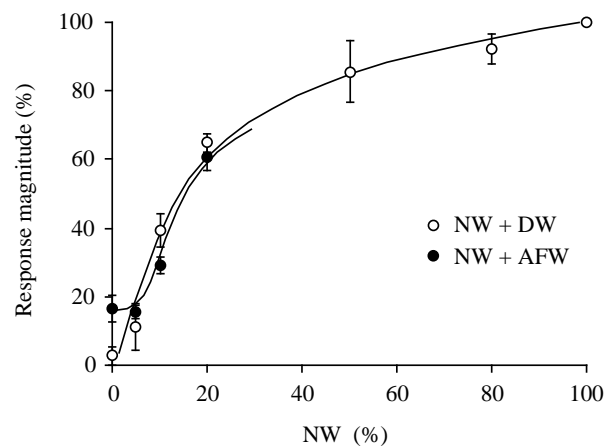

Fig. 4. Effects of dilution of natural water (NW) with distilled water (DW) and artificial fresh water (AFW) on responses to 1 mmol l^{-1} L-proline (L-Pro). Vertical bars represent S.E.M., $N=3$.

CaCl_2 , MgCl_2) and choline chloride restored the response to L-Pro to a maximum of 50% (Fig. 5). Adaptation to 10 mmol l^{-1} MgSO_4 (Fig. 5A) and sodium acetate (data not shown), salts of anions other than chloride, restored the response to 32 and 40% of the

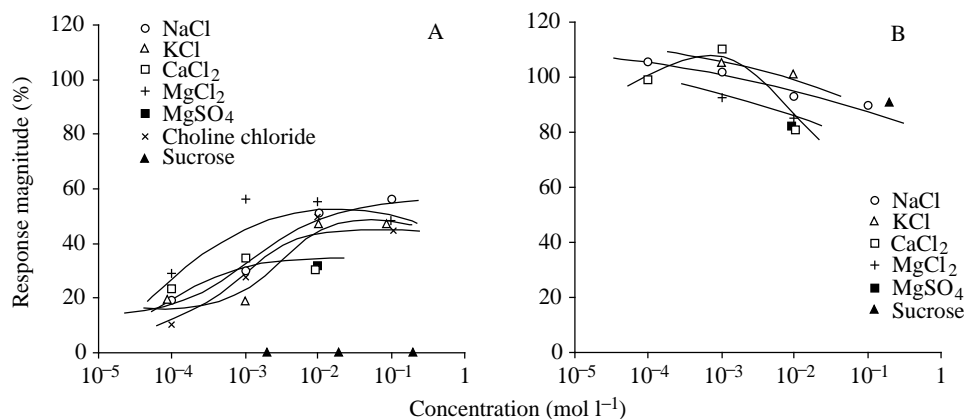

Fig. 5. Effects of addition of various salts, choline chloride and sucrose in (A) distilled water (DW) and (B) natural water (NW) on responses to 1 mmol l⁻¹ L-proline (L-Pro). Abscissa represents logarithmic concentrations of salts and sucrose (in mol l⁻¹) dissolved in (A) DW and (B) NW. Each point represents means of three experiments (S.E.M. not shown).

control response, respectively. However, adaptation to sucrose solution, a non-electrolyte, failed to restore the response to L-Pro. Therefore, response recovery was probably due to the presence of ions and not associated with changes in osmolarity. Addition of these electrolytes and non-electrolytes to NW did not increase the magnitude of the response to L-Pro beyond the control level ($P > 0.4$). Instead, there was a slight decline in the magnitude of the response when the preparations were adapted to high concentrations (10–100 mmol l⁻¹) ($P > 0.05$) (Fig. 5B).

Effects of DW and AFW on gustatory responses to other stimulants

Adaptation to DW markedly reduced or eliminated gustatory responses to Q-HCl and TLCA (Fig. 6A), whereas adaptation to AFW reduced the responses to these chemicals by about 60% (Fig. 6B). Responses to 5% CO₂ were similarly suppressed by about 60% when the palate was adapted to either DW or AFW. All the responses recovered completely 5–10 min after returning to perfusion with NW (Fig. 6A,B). The effects of various adapting solutions on gustatory responses to 1 mmol l⁻¹ L-Pro, 0.1 mmol l⁻¹ Q-HCl, 10 nmol l⁻¹ TLCA and 5% CO₂ are summarized in Fig. 7. Responses to all gustatory stimuli tested were significantly reduced when the palate was adapted to solutions other than NW ($P < 0.05$). Adaptation to DW caused the greatest reduction in responses to all gustatory stimuli, except for CO₂ which remained at 38% of the control value throughout. Responses to L-Pro, Q-HCl and TLCA were 20–40% of respective control responses during adaptation to AFW. Responses to these chemicals were improved to about 50% of the control value by adding 10 mmol l⁻¹ NaCl. However, the response to CO₂ remained unchanged with the same treatment ($P > 0.4$). Furthermore, addition of 10⁻² mol l⁻¹ NaCl to NW did not enhance the gustatory responses to any of the stimulants tested ($P > 0.1$).

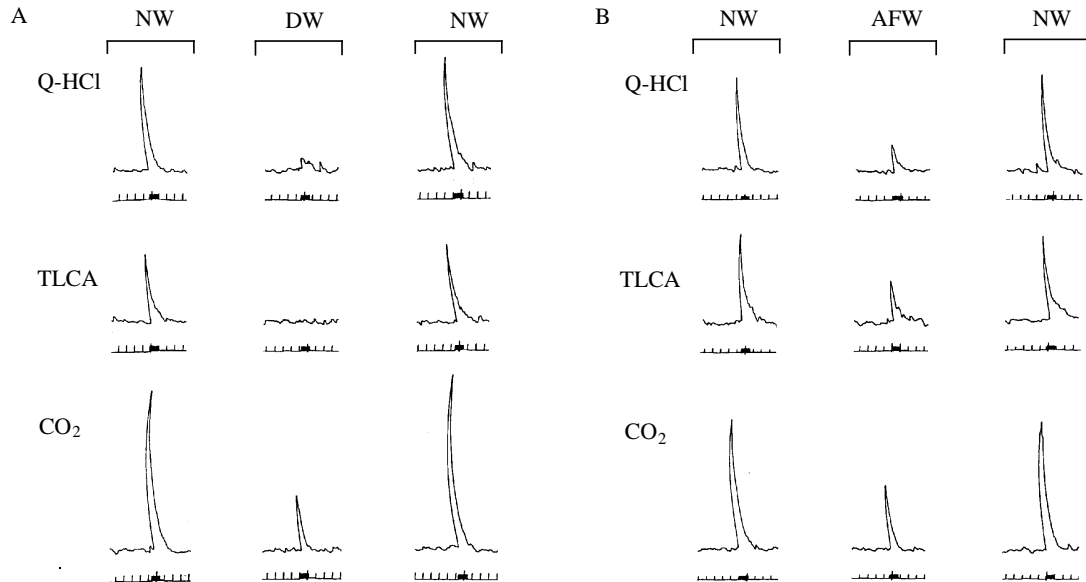

Fig. 6. Effects of adaptation to (A) distilled water (DW) and (B) artificial fresh water (AFW) on gustatory responses to 0.1 mmol l^{-1} quinine-HCl (Q-HCl), 10 nmol l^{-1} tauro lithocholic acid (TLCA) and 5% CO_2 . Left-hand traces in A and B show integrated responses in NW. Middle traces in A show integrated responses in DW. Middle traces in B show integrated responses in AFW. Right-hand traces in A and B show integrated responses in NW after recovery from adaptation to DW or AFW. The records in A and B were obtained from six different preparations. Each division of the time signal marks 5 s.

Effects of tetrodotoxin

When added to perfusing NW, $1 \mu\text{mol l}^{-1}$ TTX had no effect on the gustatory responses elicited by 1 mmol l^{-1} L-Pro. The response magnitude remained unchanged during the 5 min perfusion period and after the preparation had been returned to NW (Fig. 8).

Discussion

Suppression of gustatory responses by DW and AFW

The magnitude of the gustatory responses to L-Pro recorded from the whole palatine nerve bundle was greatly reduced or nearly abolished within 5 min of perfusion of the palate with DW. Similarly, adaptation to AFW reduced the responses to L-Pro to about 27% of those in NW. Response levels to L-Pro showed a gradual decrease with increasing dilution of NW, even though the concentrations of major cations were held constant. This was essentially the case with the other gustatory stimuli, including Q-HCl and TLCA. The results suggest that NW is essential to ensure maximal gustatory responses to known chemicals. Because the addition of major cations to DW did not fully restore the gustatory responses, substances other than these ions must be primarily responsible for the

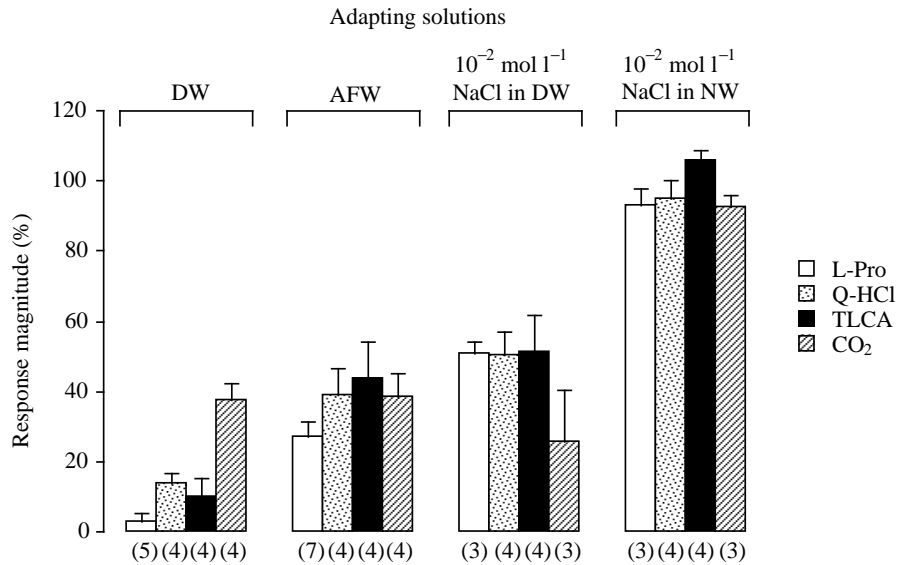

Fig. 7. Effects of addition of NaCl (10 mmol l^{-1}) on gustatory responses recorded in DW and NW. The ordinate represents the relative magnitude of the response to taste stimuli after adaptation to distilled water (DW) or artificial fresh water (AFW). The gustatory stimuli used were 1 mmol l^{-1} L-proline (L-Pro), 0.1 mmol l^{-1} quinine-HCl (Q-HCl), 10 nmol l^{-1} tauroolithocholic acid (TLCA) and 5% CO_2 . Numerals in parentheses indicate the number of preparations on which the average response magnitude is based. Bars indicate S.E.M.

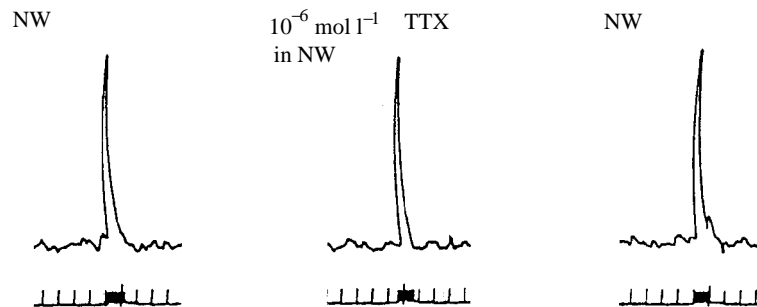

Fig. 8. Gustatory responses to 1 mmol l^{-1} L-Pro before, during and after treatment with $1 \mu\text{mol l}^{-1}$ tetrodotoxin (TTX) for 5 min. NW, natural water. Time signal, each division marks 5 s.

maintenance of the response in NW. In the rat chorda tympani nerve, gustatory responses are dependent on $[\text{HCO}_3^-]$ and/or the pH of the surrounding medium (Matsuo and Yamamoto, 1992). However, in the present study, addition of 1 mmol l^{-1} NaHCO_3 to DW (pH 7.8–7.9, close to that of NW) had no effect, suggesting that neither HCO_3^- nor pH plays a key role in maintaining the gustatory response in rainbow trout. This is

consistent with earlier findings that the gustatory responses to L-Pro remain unchanged over a wide range of pH (Marui *et al.* 1983; Kiyohara *et al.* 1984). In NW-deficient conditions (i.e. when the palate was irrigated either with DW or AFW), responses to gustatory substances were restored up to a maximum of 50% of those of respective control responses by addition of a maximum of 10 mmol l^{-1} salts to the perfusing media. There were no significant differences in the effect among types of cations (mono- or divalent) or anions (Cl^- , SO_4^{2-} or acetate). Thus, external ions support gustatory responses to some extent. However, addition of the same concentration of salts to NW did not improve the responses to stimuli. These results indicate that NW contains ions at levels sufficient to maximize the gustatory response and that adding amounts beyond these levels had very little effect.

The responses to CO_2 remained at about 40% of the control value during adaptation to DW and were independent of added salts. In contrast, responses to L-Pro, Q-HCl and TLCA during adaptation to diluted NW were all dependent on salt concentrations. Thus, the receptor mechanism for CO_2 in rainbow trout seems to be different from those for other gustatory chemicals. This supports the demonstration of Yamashita *et al.* (1989) that single palatine nerve fibres responding to CO_2 do not respond to other gustatory stimuli, including amino acids and bile salts. During gustatory stimulation with L-Pro, Q-HCl and TLCA, interactions of the stimulus with molecules on the apical membrane of the gustatory cells are probably the initial process of gustatory transduction (for a review, see Kinnamon and Cummings, 1992), whereas during CO_2 stimulation small CO_2 molecules can permeate directly through the cell membrane (Hidaka, 1970; Yoshii *et al.* 1980). It is likely that specific binding of stimulus molecules could be affected by ions in the environment more readily than could direct permeation of small molecules such as CO_2 .

Importance of NW in gustation

All responses to gustatory stimuli elicited in AFW and particularly DW were much reduced in rainbow trout. The addition of salts improved the responses in DW to some extent. In their study with the eel palatal organ, Yoshii and Kurihara (1983) pretreated the epithelium with 5 mmol l^{-1} EDTA to remove all possible ions from the surface of the palate. Despite the EDTA treatment, adaptation to DW did not always inhibit gustatory responses to amino acids and addition of salts resulted in complete restoration of responses. The two studies may be different because different species were used. However, differences in experimental procedures cannot be ruled out. In the present experiments, the palatal organ was continuously perfused with NW at a rate of 0.2 ml s^{-1} , unless stated otherwise. In the eel experiments (Yoshii and Kurihara, 1983), the palate was irrigated with perfusing solutions for 4 min and a stimulant solution was applied at a flow rate of 0.5 ml s^{-1} . After stimulation, the palate was rinsed with the perfusing solution. Perhaps a substance(s) that supports gustatory responses is more easily removed from the surface of the rainbow trout palate than from the eel palate. Eels are known for their copious production of a variety of mucosubstances. Because goblet cell mucosubstances are relatively uniform in their histochemical characteristics throughout eel epithelial tissues, it is highly likely that the eel gustatory cells are covered with thick

mucus rich in a neuraminic acid containing mucosaccharides (Yamada and Yokote, 1975). Although we did not examine the effects of the removal of ions from NW, both inorganic cations and unknown substances may be required to achieve maximal gustatory responses in both species.

Ion channels

L-Arginine-activated (Teeter *et al.* 1990; Brand and Bruch, 1992) and L-proline-activated (Kumazawa *et al.* 1990; Brand *et al.* 1991) cation channels have been demonstrated in reconstituted gustatory epithelium membranes from channel catfish (*Ictalurus punctatus*) (reviewed by Caprio *et al.* 1993). Both types of channel are permeable to Na⁺, K⁺, Ca²⁺ and Ba²⁺. In the present study, however, addition of these salts to NW did not augment gustatory responses to L-Pro, suggesting that an L-Pro-activated cation channel may not be involved in gustatory transduction *in vivo* in rainbow trout.

Perfusion of the palate with TTX at 1 $\mu\text{mol l}^{-1}$ for more than 5 min had no effect on gustatory responses to L-Pro. The TTX-sensitive, voltage-dependent Na⁺ current is known to be present in most gustatory cells (Kinnamon and Cummings, 1992). In frog (*Rana ridibunda*), the transient inward Na⁺ current in a patch-clamped gustatory cell was completely blocked by 0.1 $\mu\text{mol l}^{-1}$ TTX present in the bath (Avenet and Lindemann, 1987). However, *in vivo* experiments by Ozeki and Noma (1972) demonstrated that the generation of a receptor potential in response to gustatory stimuli was not inhibited by TTX at 3.08 $\mu\text{mol l}^{-1}$. The present results, together with our earlier studies with rainbow trout and Arctic char (Yamamori *et al.* 1988), suggest that the L-Pro-activated TTX-sensitive cation channel(s) is not present in the apical membrane of the gustatory cells and that TTX does not penetrate the tight junctions found at the top of the gustatory cells. Because responses to other gustatory substances are also independent of ions in the medium, the same mechanism may be widely distributed in the fish gustatory system.

Five to six minutes was required for the suppression of the gustatory responses by DW and diluted NW to be completed, and even longer periods were needed for a complete recovery. This is consistent with our interpretation that the unknown substance(s) essential for the maximal gustatory response in rainbow trout is not a simple physicochemical factor, such as ionic conditions, pH or osmolarity of the medium. Instead, it suggests that mucous substances covering the apical membrane of the gustatory cell may be involved in the action, possibly acting as a reservoir or carrier of the unknown substance that is continuously replenished by the NW. A number of studies routinely employ distilled water, artificial fresh water or sea water for perfusion and as media for chemical stimulants (e.g. Yoshii *et al.* 1979; Kiyohara *et al.* 1981; Kiyohara and Hidaka, 1991; Hidaka *et al.* 1992).

Cautious interpretation of data will be required if the phenomena observed in the present study are common in other fish species. These avenues of research represent a new approach that is worth pursuing.

This work was supported in part by a Japan Science and Technology Fund (061-92-047). Y.K. was supported by a grant for research abroad from the Ministry of Education of Japan. The authors are grateful to C. Zhang for technical assistance.

References

- AVENET, P. AND LINDEMANN, B. (1987). Patch-clamp study of isolated taste receptor cells of the frog. *J. Membr. Biol.* **97**, 223–240.
- BEIDLER, L. M. (1971). Taste receptor stimulation with salts and acids. In *Handbook of Sensory Physiology*, vol. 42 (ed. L. M. Beidler), pp. 200–220. Berlin: Springer-Verlag.
- BRAND, J. G. AND BRUCH, R. C. (1992). Molecular mechanisms of chemosensory transduction: gustation and olfaction. In *Fish Chemoreception* (ed. T. J. Hara), pp. 126–149. London: Chapman and Hall.
- BRAND, J. G., TEETER, J. H., KUMAZAWA, T., HUQUE, T. AND BAYLEY, D. L. (1991). Transduction mechanisms for the taste of amino acids. *Physiol. Behav.* **49**, 899–904.
- BROWN, S. B., EALES, J. G., EVANS, R. E. AND HARA, T. J. (1984). Interrenal, thyroidal and carbohydrate responses of rainbow trout (*Salmo gairdneri*) to environmental acidification. *Can. J. Fish. aquat. Sci.* **41**, 36–45.
- CAPRIO, J., BRAND, J. G., TEETER, J. H., VALENTINCIC, T., KALINOSKI, D. L., KOHBARA, J., KUMAZAWA, T. AND WEGERT, S. (1993). The taste system of the channel catfish: from biophysics to behavior. *Trends Neurosci.* **16**, 192–197.
- HARA, T. J. (1993). Chemoreception. In *The Physiology of Fishes* (ed. D. H. Evans), pp. 191–218. Boca Raton: CRC Press.
- HARA, T. J., MACDONALD, S., EVANS, R. E., MARUI, T. AND ARAI, S. (1984). Morpholine, bile acids and skin mucus as possible chemical cues in salmonid homing: electrophysiological re-evaluation. In *Mechanisms of Migration in Fishes* (ed. J. D. McCleave, G. P. Arnold, J. D. Dodson and W. H. Neill), pp. 363–378. New York: Plenum Publishing Corp.
- HARA, T. J., SVEINSSON, T., EVANS, R. E. AND KLAPRAT, D. A. (1993). Morphological and functional characteristics of the olfactory and gustatory organs of three *Salvelinus* species. *Can. J. Zool.* **71**, 414–423.
- HIDAKA, I. (1970). The effect of carbon dioxide on the carp palatal chemoreceptors. *Bull. Jap. Soc. scient. Fish.* **36**, 1034–1039.
- HIDAKA, I., ZENG, C. AND KOHBARA, J. (1992). Gustatory responses to organic acids in the yellowtail *Seriola quinqueradiata*. *Nippon Suisan Gakkaishi* **58**, 1179–1187.
- JAKUBOWSKI, M. AND WHITEAR, M. (1990). Comparative morphology and cytology of taste buds in teleosts. *Z. mikrosk.-anat. Forsch.* **104**, 529–560.
- KINNAMON, S. C. AND CUMMINGS, T. A. (1992). Chemosensory transduction mechanisms in taste. *A. Rev. Physiol.* **54**, 715–731.
- KIYOHARA, S. AND HIDAKA, I. (1991). Receptor sites for alanine, proline and betaine in the palatal taste system of the puffer, *Fugu pardalis*. *J. comp. Physiol. A* **169**, 523–530.
- KIYOHARA, S., YAMASHITA, S. AND HARADA, S. (1981). High sensitivity of minnow gustatory receptors to amino acids. *Physiol. Behav.* **26**, 1103–1108.
- KIYOHARA, S., YAMASHITA, S. AND HIDAKA, I. (1984). Effects of pH on the gustatory responses to amino acids in the puffer, *Fugu pardalis*. *Proc. Jap. Symp. Taste Smell* **18**, 61–64.
- KLAPRAT, D. A., EVANS, R. E. AND HARA, T. J. (1992). Environmental contaminants and chemoreception in fishes. In *Fish Chemoreception* (ed. T. J. Hara), pp. 321–341. London: Chapman and Hall.
- KUMAZAWA, T., TEETER, J. H. AND BRAND, J. G. (1990). L-Proline-activated cation channels in isolated catfish taste epithelial membranes. *Chem. Senses* **15**, 603–604.
- MARUI, T., EVANS, R. E., ZIELINSKI, B. AND HARA, T. J. (1983). Gustatory responses of the rainbow trout (*Salmo gairdneri*) palate to amino acids and derivatives. *J. comp. Physiol. A* **153**, 423–433.
- MATSUO, R. AND YAMAMOTO, T. (1992). Effects of inorganic constituents of saliva on taste responses of the rat chorda tympani nerve. *Brain Res.* **583**, 71–80.
- OZEKI, M. AND NOMA, A. (1972). The action of tetrodotoxin, procaine and acetylcholine on gustatory reception in frog and rat. *Jap. J. Physiol.* **22**, 467–475.
- REUTTER, K. (1992). Structure of the peripheral gustatory organ, represented by the siluroid fish *Plotosus lineatus* (Thunberg). In *Fish Chemoreception* (ed. T. J. Hara), pp. 60–78. London: Chapman and Hall.
- STANTON, M. P., CAPEL, M. J. AND ARMSTRONG, F. A. G. (1974). The chemical analysis of fresh water. *Fish. Res. Bd Can. misc. spec. Publ.* **25**, 125pp.
- TEETER, J. H., BRAND, J. G. AND KUMAZAWA, T. (1990). A stimulus-activated conductance in isolated taste epithelial membrane. *Biophys. J.* **58**, 253–259.
- WAGEMANN, R., SCHERER, E. AND CZWARNO, J. (1987). New water treatment system at the Freshwater

- Institute: description and performance evaluation after one year of operation (1985/86). *Can. Manuscr. Rep. Fish. aquat. Sci. 1919*: iv+30pp.
- YAMADA, K. AND YOKOTE, M. (1975). Morphochemical analysis of mucosubstances in some epithelial tissues of the eel (*Anguilla japonica*). *Histochemistry* **43**, 161–172.
- YAMAMORI, K., NAKAMURA, M., MATSUI, T. AND HARA, T. J. (1988). Gustatory responses to tetrodotoxin and saxitoxin in fish: a possible mechanism for avoiding marine toxins. *Can. J. Fish. aquat. Sci.* **45**, 2182–2186.
- YAMASHITA, S., EVANS, R. E. AND HARA, T. J. (1989). Specificity of the gustatory chemoreceptors for CO₂ and H⁺ in rainbow trout (*Oncorhynchus mykiss*). *Can. J. Fish. aquat. Sci.* **46**, 1730–1734.
- YOSHII, K., KAMO, N., KURIHARA, K. AND KOBATAKE, Y. (1979). Gustatory responses of eel palatine receptors to amino acids and carboxylic acids. *J. gen. Physiol.* **74**, 301–317.
- YOSHI, K., KASHIWAYANAGI, M., KURIHARA, K. AND KOBATAKE, Y. (1980). High sensitivity of the eel palatine receptors to carbon dioxide. *Comp. Biochem. Physiol.* **66A**, 327–330.
- YOSHII, K. AND KURIHARA, K. (1983). Ion dependence of the eel taste response to amino acids. *Brain Res.* **280**, 63–67.